

REV
SH
R110
DWG NO

REVISIONS			
REV	DESCRIPTION	DATE	APPROVED

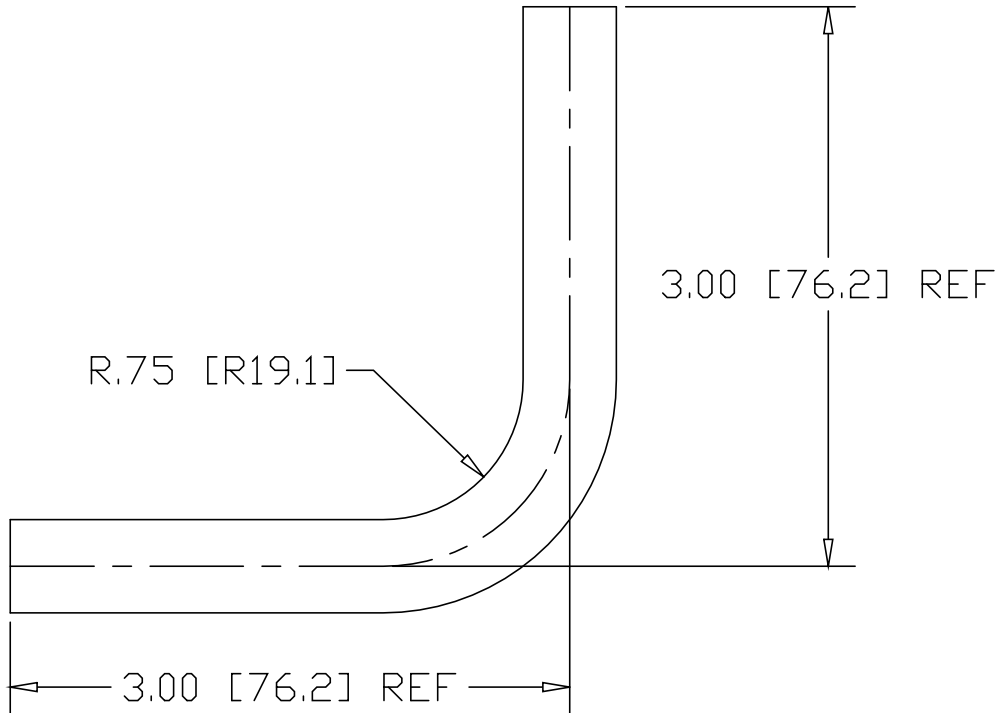
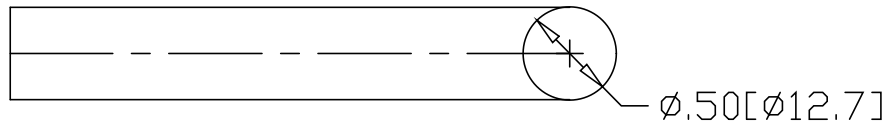

NOTE: ENDS UNTRIMMED

INCHES[MILLIMETERS]

ALTERNATE MATERIAL	PART NUMBER
1/2" ϕ 304 STAINLESS STEEL BAR	R120
1/2" ϕ 6063 ALUMINUM BAR	R240
1/2" ϕ 360 BRASS BAR	R130
1/2" ϕ 385 ARCH BRONZE BAR	R210

PART NAME		1/2" ϕ BAR BEND	
MATERIAL		1/2" ϕ COLD ROLLED STEEL BAR	
DATE	11/20/98	 THE WAGNER COMPANIES R & B WAGNER, INC. AND J. G. BRAUN CO.	
DRAWN BY	RJF		
FINISH	MILL		
SIZE	A	WEIGHT	.31 LBS
		PART NUMBER	R110
		REV	