

2

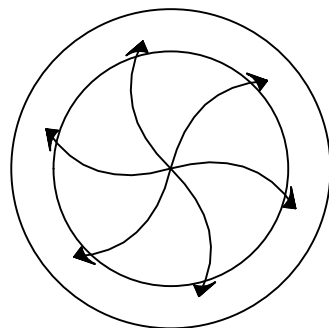

1

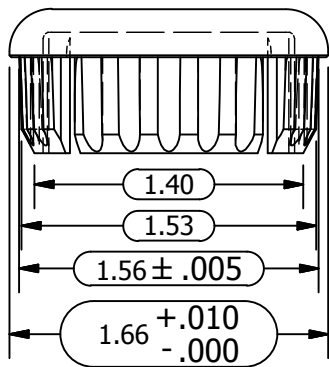

FINISH DIRECTION



B

B

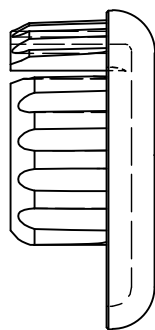
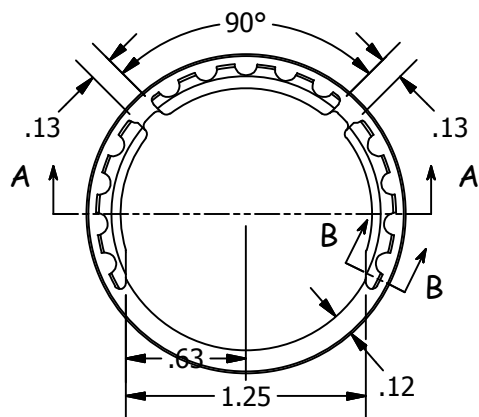

THIS SIDE
#4 SATIN FINISH



A

A

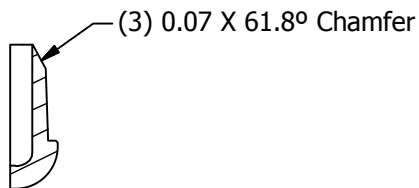
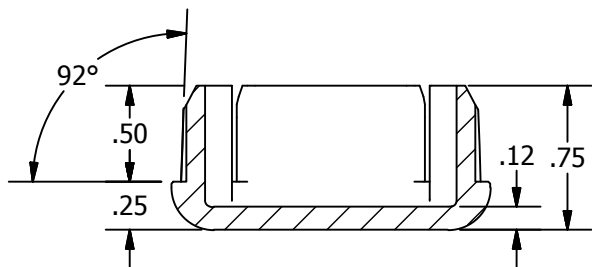

SECTION B-B

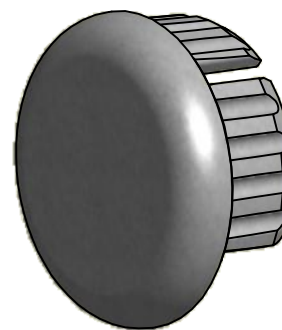

SECTION A-A

TOLERANCE X.X..... = ± .060 X.XX..... = ± .030 X.XXX..... = ± .010 XX°..... = ± 1° UNLESS OTHERWISE NOTED	CUT LENGTH:	FINISH:	DESCRIPTION:	
		#4 Satin	ENDCAP SS GLASS RAIL, FOR 1.66 OD, ALL CHANNELS	
	DEVELOPED LENGTH:	WEIGHT:	MATERIAL:	MATERIAL DESC:
		0.12 lbmass	316 Stainless Steel	
TOOL NUMBER:		DATE:	REV:	
		2/18/2015	-	
		PART NUMBER:	COLLABORATIVE METAL WORKS	
		GR3169E.4		

2



1