

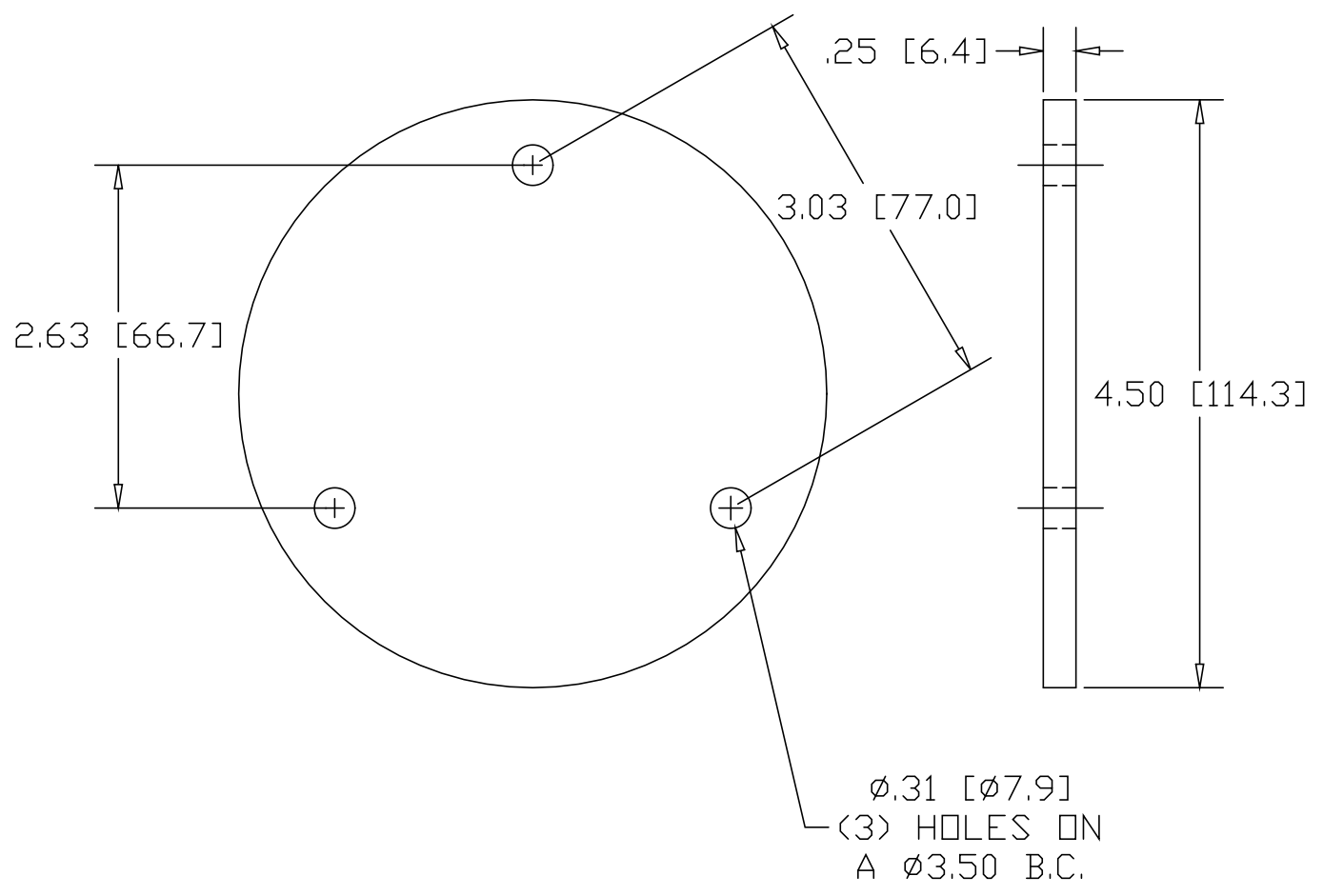

REV
SH
D246H
DWG NO

REVISIONS			
REV	DESCRIPTION	DATE	APPROVED



INCHES [MILLIMETERS]

ALTERNATE MATERIAL	PART NUMBER
.250 (3003) ALUMINUM ASTM B209	D247H
.250 (304) STAINLESS STEEL ASTM A240	D248H

PART NAME 4.50" BASE DISK WITH (3) MTG HOLES				
MATERIAL .250 HRP&D STEEL ASTM A569				
DATE 11/20/98	 THE WAGNER COMPANIES R & B WAGNER, INC. AND J. G. BRAUN CO.			
DRAWN BY RJF				
FINISH MILL		SIZE A	WEIGHT .94 LBS	PART NUMBER D246H
			REV	