

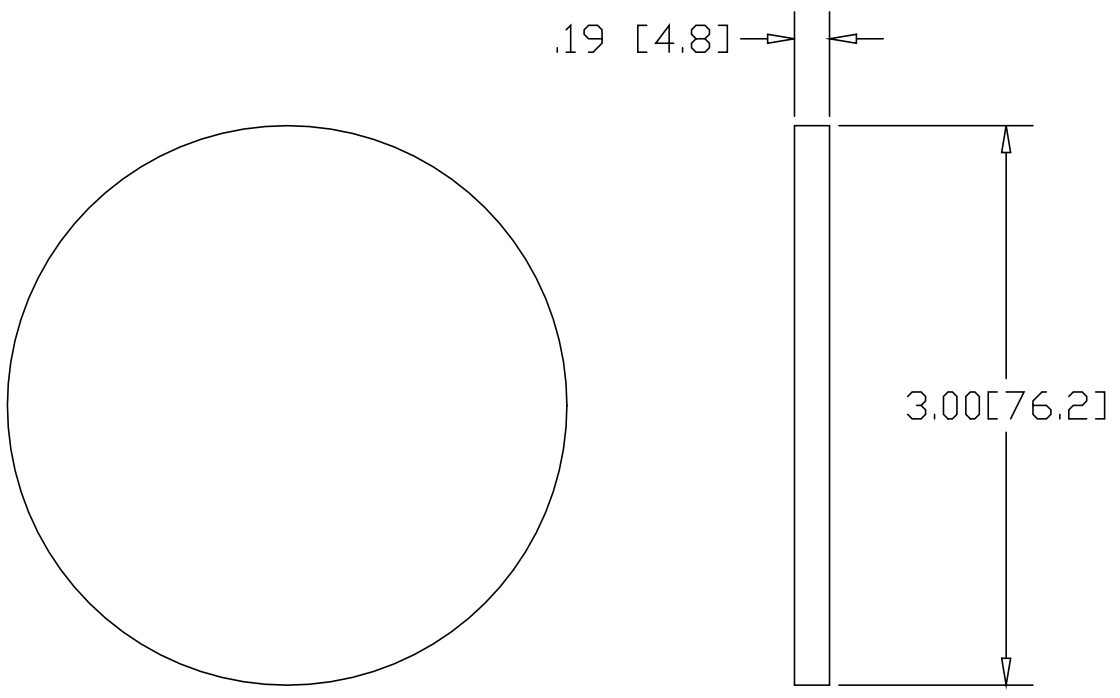

REV
SH
DWG NO D139

REVISIONS			
REV	DESCRIPTION	DATE	APPROVED



INCHES[MILLIMETERS]

ALTERNATE MATERIAL	PART NUMBER
.190 (3003) ALUMINUM ASTM B209	D140
7 GA 304 STAINLESS STEEL ASTM A240	D141
.188 (260) BRASS ASTM B19,B36	D142

PART NAME 3.00" OD TUBE SIZE TYPE-D WELD-ON DISK			
MATERIAL 7 GA. HRP&O STEEL ASTM A569			
DATE 11/20/98		THE WAGNER COMPANIES R & B WAGNER, INC. AND J. G. BRAUN CO.	
DRAWN BY RJF			
FINISH MILL			
SIZE A	WEIGHT .38 LBS	PART NUMBER D139	REV