

REV
SH
DWG NO B4155

REVISIONS			
REV	DESCRIPTION	DATE	APPROVED

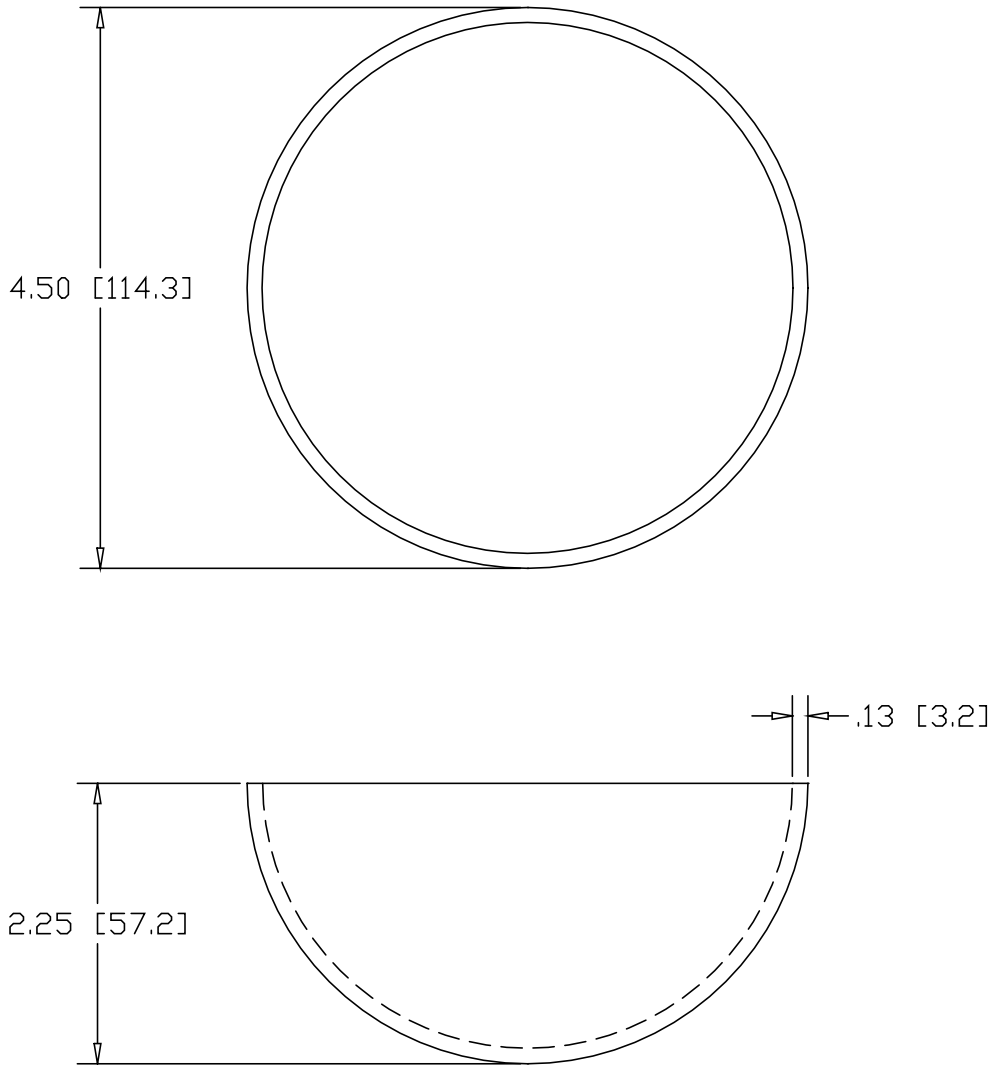

INCHES [MILLIMETERS]

ALTERNATE MATERIAL	PART NUMBER
.125 (3003) ALUMINUM SHEET ASTM B209	B4157
11 GA. (.1200) 304 STAINLESS STEEL A240	B4158
.125 (260) BRASS	B4159
.125 (655) SILICON BRONZE	BSB4155

PART NAME		4.50" HEMISPHERE	
MATERIAL		11 GA. (.1196) HRP&D STEEL SHEET ASTM A569	
DATE	1/4/00		THE WAGNER COMPANIES R & B WAGNER, INC. AND J. G. BRAUN CO.
DRAWN BY	RJF		
FINISH	MILL		
SIZE	A	WEIGHT	1.06 LBS
PART NUMBER		B4155	
REV			