

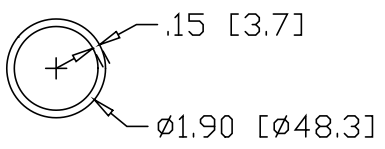

REV
SH
8308
DWG NO

REVISIONS			
REV	DESCRIPTION	DATE	APPROVED

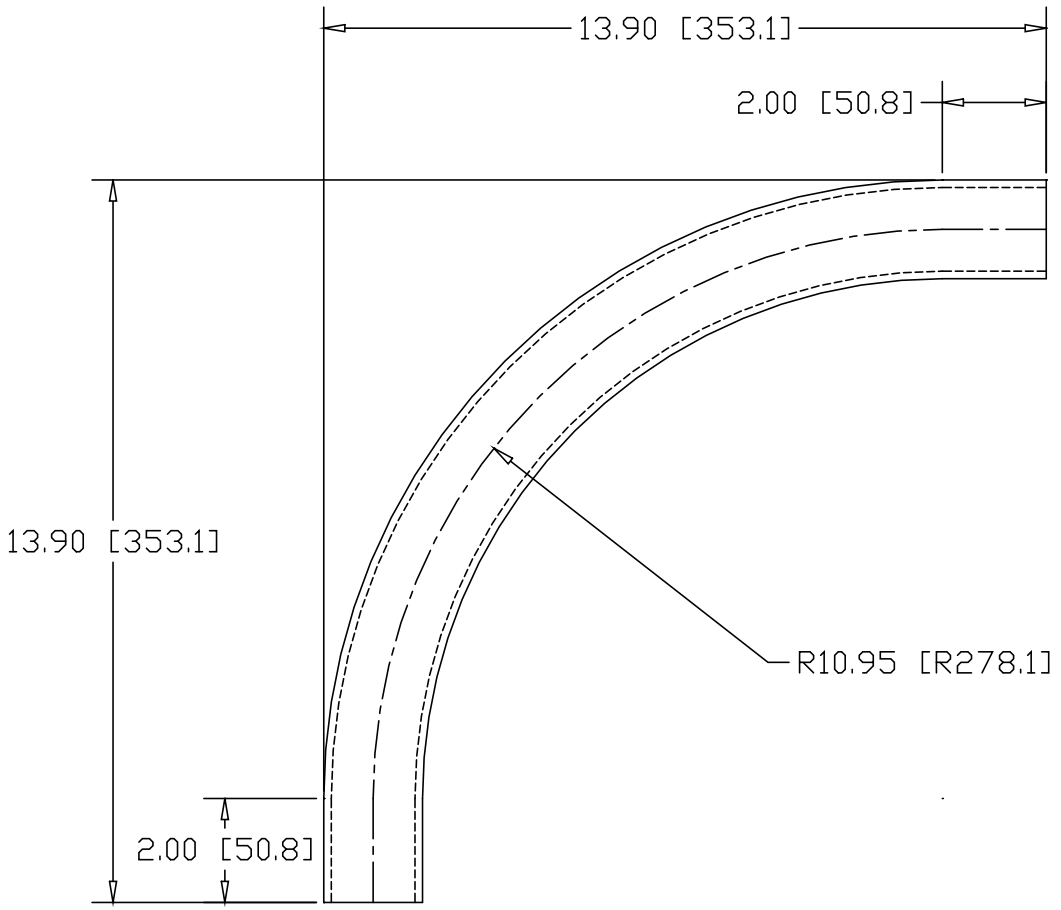

INCHES [MILLIMETERS]

ALTERNATE MATERIAL	PART NUMBER
1-1/2" SCH 40 (6063) ALUMINUM PIPE	8322
1-1/2" SCH 40 (304) STAINLESS STEEL PIPE	8336

PART NAME 1-1/2" PIPE SIZE 90° ELL X 10" I.R. W/ (2) 2" TANGENTS			
MATERIAL 1-1/2" SCH 40 A53 STEEL PIPE			
DATE 8/7/01		R & B WAGNER, INC.	
DRAWN BY JAH		SIZE A	WEIGHT 4.81 LBS
FINISH MILL		PART NUMBER 8308	REV