

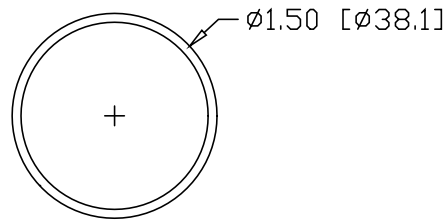

REV
SH
7905
DWG NO

REVISIONS			
REV	DESCRIPTION	DATE	APPROVED

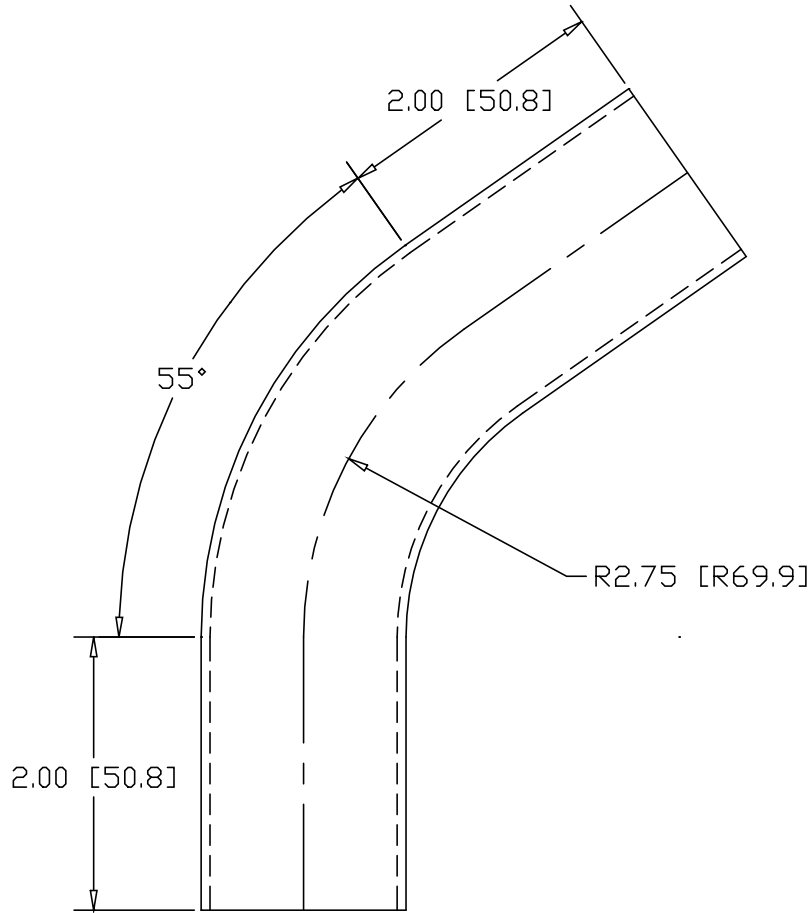

INCHES [MILLIMETERS]

ALTERNATE MATERIAL	PART NUMBER
1.50" O.D. X .125W (6061-T1) ALUMINUM TUBE	7921
1.50" O.D. X .065W (304) STAINLESS STEEL TUBE	7937

PART NAME 1.50" O.D. TUBE 55° ELL X 2.75" CLR W/(2) 2" TANGENTS				
MATERIAL 1.50" O.D. X .065W STEEL TUBE				
DATE 8/15/00	 R & B WAGNER, INC.			
DRAWN BY RJF				
FINISH MILL	SIZE A	WEIGHT .56 LBS	PART NUMBER 7905	REV