

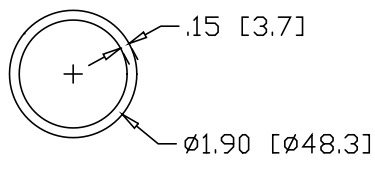

REV
SH
7756
DWG NO

REVISIONS			
REV	DESCRIPTION	DATE	APPROVED

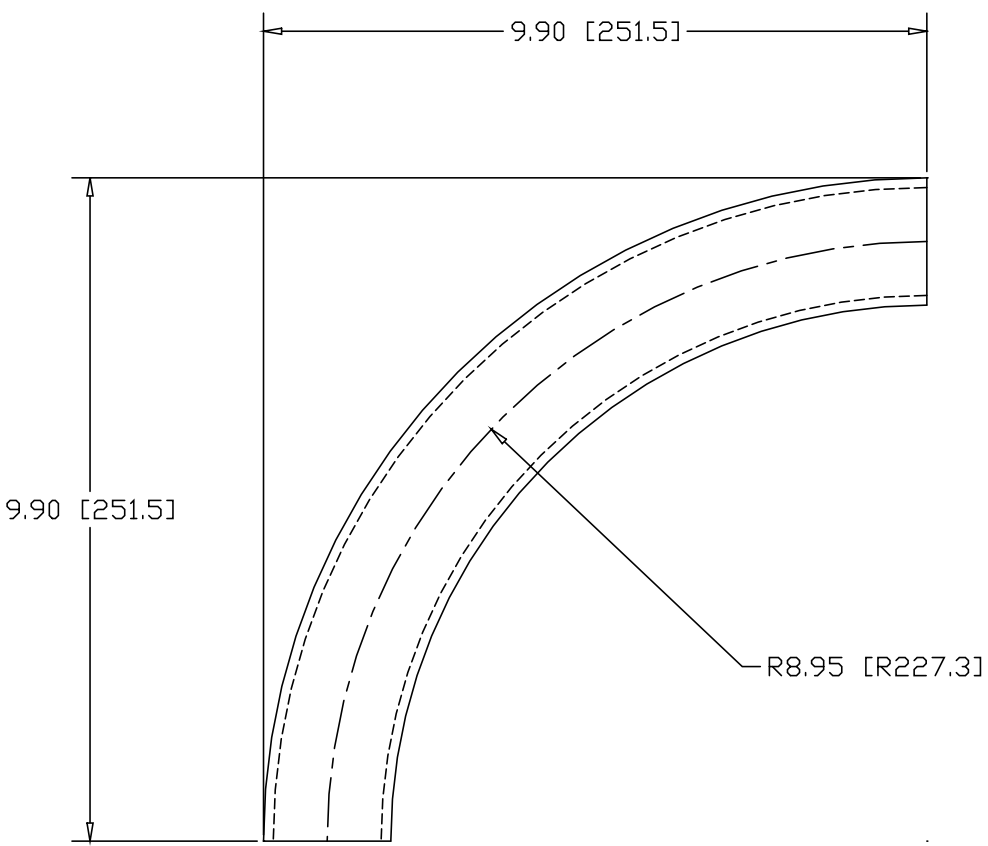

INCHES [MILLIMETERS]

ALTERNATE MATERIAL	PART NUMBER
1-1/2" SCH 40 (6063) ALUMINUM PIPE	7770
1-1/2" SCH 40 (304) STAINLESS STEEL PIPE	7784

PART NAME		1-1/2" PIPE SIZE 90° ELL X 8" I.R.					
MATERIAL		1-1/2" SCH 40 A53 STEEL PIPE					
DATE	7/30/01	 R & B WAGNER, INC.					
DRAWN BY	JAH						
FINISH	MILL						
SIZE	A	WEIGHT	3.15 LBS	PART NUMBER	7756	REV	