

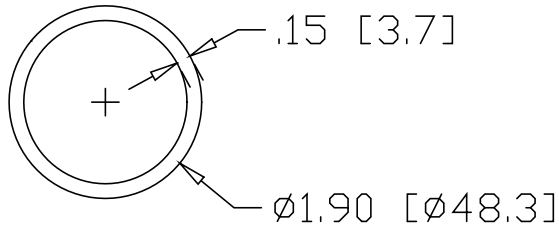

REV  
SH  
7523  
DWG NO

REVISIONS			
REV	DESCRIPTION	DATE	APPROVED

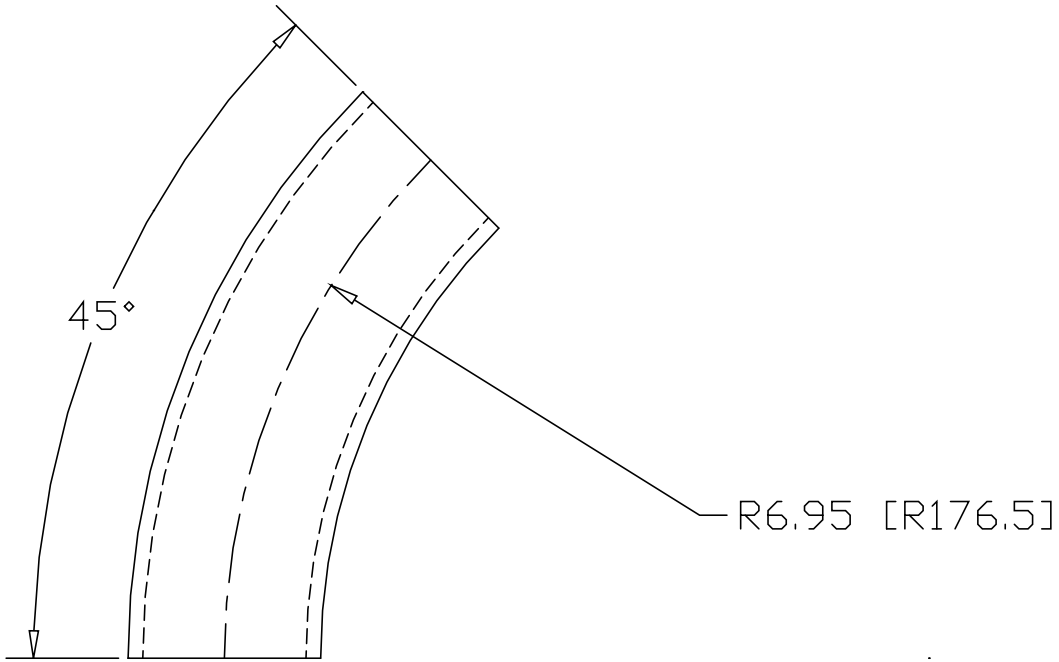

INCHES [MILLIMETERS]

ALTERNATE MATERIAL	PART NUMBER
1-1/2" SCH 40 (6063) ALUMINUM PIPE	7543
1-1/2" SCH 40 (304) STAINLESS STEEL PIPE	7563

PART NAME		1-1/2" PIPE SIZE 45° ELL X 6" I.R.					
MATERIAL		1-1/2" SCH 40 A53 STEEL PIPE					
DATE	7/05/01	 <b>R &amp; B WAGNER, INC.</b>					
DRAWN BY	JAH						
FINISH	MILL						
SIZE	A	WEIGHT	1.24 LBS	PART NUMBER	7523	REV	