

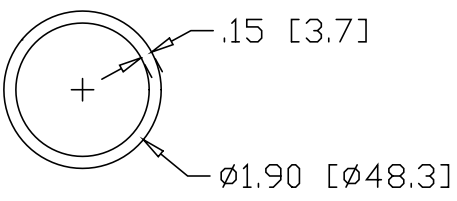

REV  
SH  
7527  
DWG NO

REVISIONS			
REV	DESCRIPTION	DATE	APPROVED

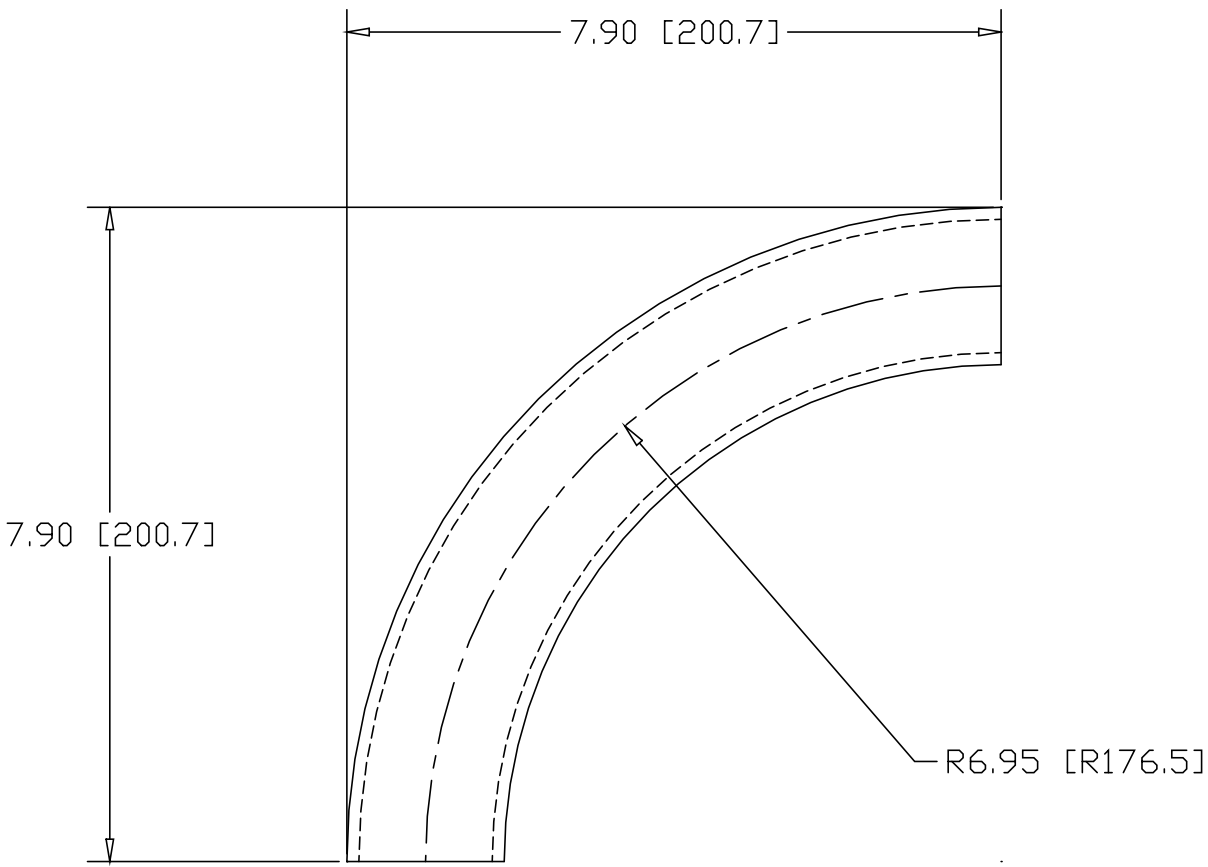

INCHES [MILLIMETERS]

ALTERNATE MATERIAL	PART NUMBER
1-1/2" SCH 40 (6063) ALUMINUM PIPE	7547
1-1/2" SCH 40 (304) STAINLESS STEEL PIPE	7567

PART NAME		1-1/2" PIPE SIZE 90° ELL X 6" I.R.					
MATERIAL		1-1/2" SCH 40 A53 STEEL PIPE					
DATE	7/05/01	 <b>R &amp; B WAGNER, INC.</b>					
DRAWN BY	JAH						
FINISH	MILL						
SIZE	A	WEIGHT	2.48 LBS	PART NUMBER	7527	REV	