

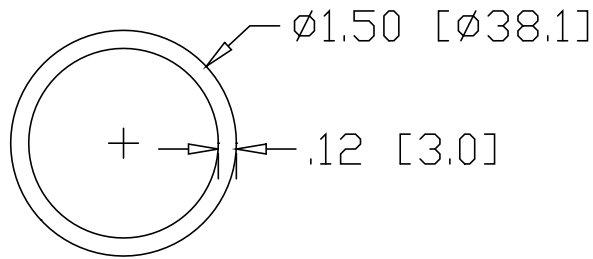

REV  
SH  
6950  
DWG NO

REVISIONS			
REV	DESCRIPTION	DATE	APPROVED

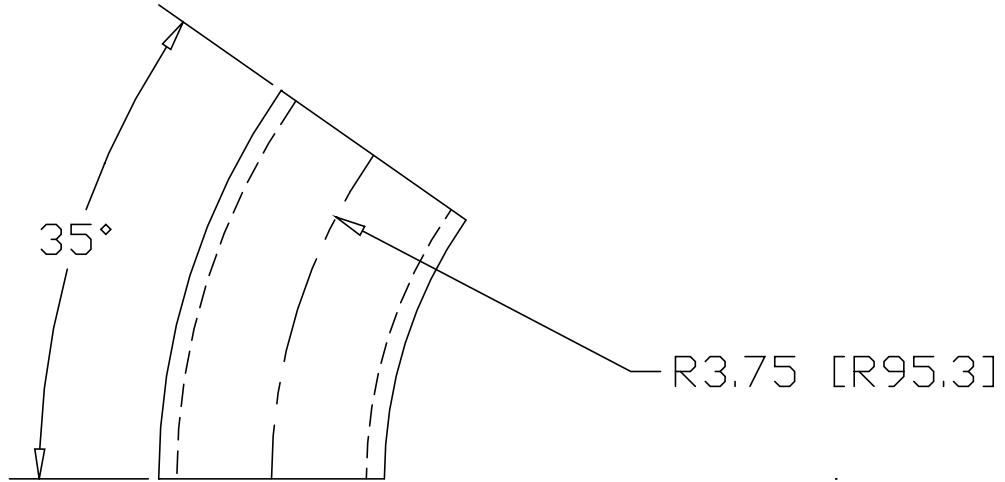

INCHES [MILLIMETERS]

PART NAME		1.50" O.D. TUBE 35° ELL X 3.75" CLR					
MATERIAL		1.50" O.D. X .120W STEEL TUBE					
DATE	9/22/00		<b>THE WAGNER COMPANIES</b> R & B WAGNER, INC. AND J. G. BRAUN CO.				
DRAWN BY	RJF						
FINISH	MILL						
SIZE	A	WEIGHT	.34 LBS	PART NUMBER	6950	REV	