

REV

SH

6901

DWG NO

REVISIONS

REV

DESCRIPTION

DATE

APPROVED

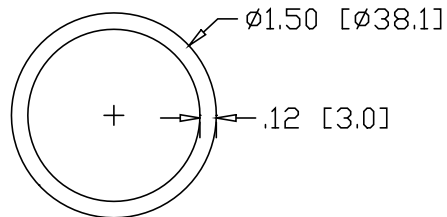
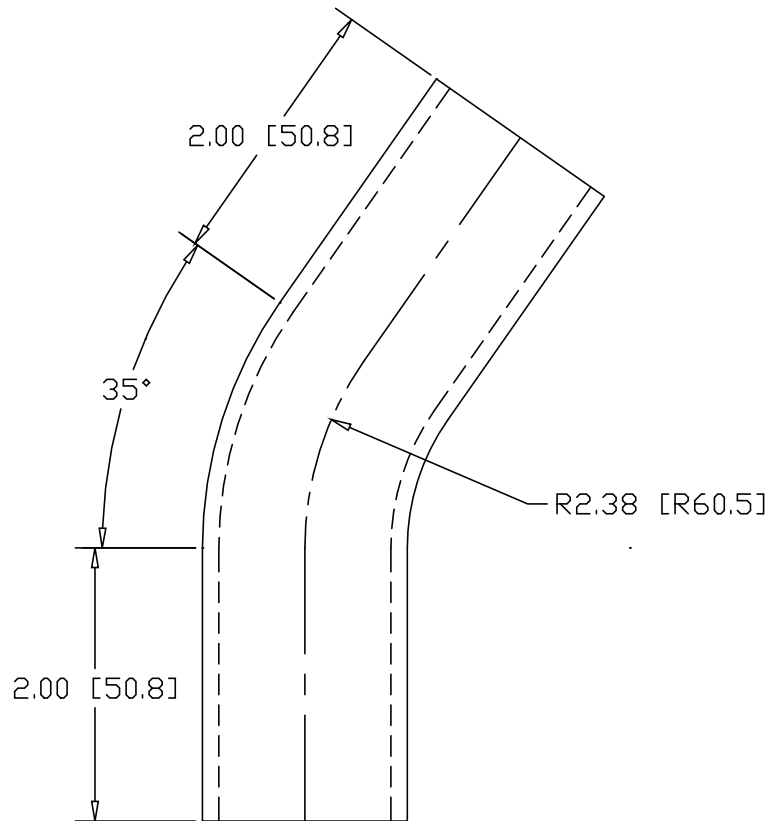

INCHES [MILLIMETERS]

ALTERNATE MATERIAL	PART NUMBER
1.50" O.D. X .125W (6061-T1) ALUMINUM TUBE	6917
1.50" O.D. X .120W (304) STAINLESS STEEL TUBE	6933

PART NAME		1.50" O.D. TUBE 35° ELL X 2.38" CLR W/(2) 2" TANGENTS				
MATERIAL		1.50" O.D. X .120W STEEL TUBE				
DATE	9/12/00	 R & B WAGNER, INC.				
DRAWN BY	RJF					
FINISH	MILL					
SIZE	A	WEIGHT	.81 LBS	PART NUMBER	6901	REV