

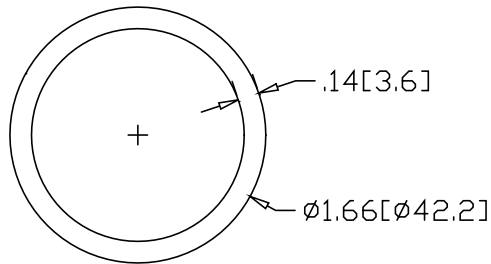

REV
SH
DWG NO 4638

REVISIONS			
REV	DESCRIPTION	DATE	APPROVED

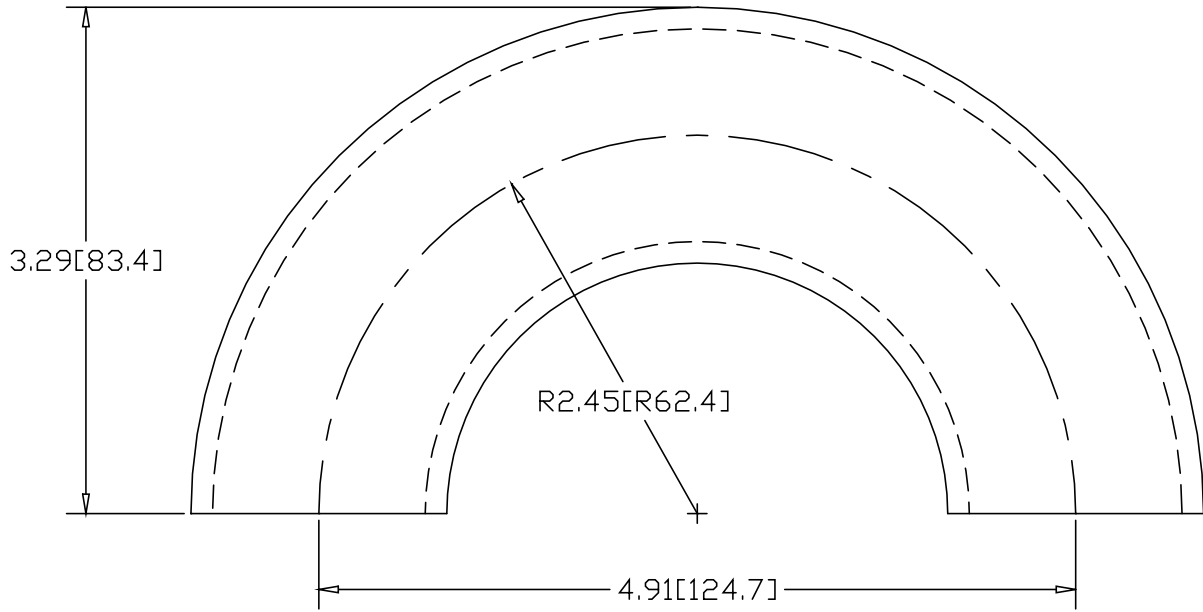

INCHES [MILLIMETERS]

ALTERNATE MATERIAL	PART NUMBER
1-1/4" SCH 40 (6063) ALUMINUM PIPE	4648
1-1/4" SCH 40 (304) STAINLESS STEEL PIPE	4660

PART NAME				1-1/4" PIPE SIZE 180° ELL X 1-5/8" I.R.	
MATERIAL				1-1/4" SCH 40 STEEL PIPE	
DATE	8/18/95			R & B WAGNER, INC.	
DRAWN BY	RJF				
FINISH	MILL	SIZE	A	WEIGHT	1.22 LBS
			PART NUMBER	4638	REV