

REV
SH
4464
DWG NO

REVISIONS			
REV	DESCRIPTION	DATE	APPROVED

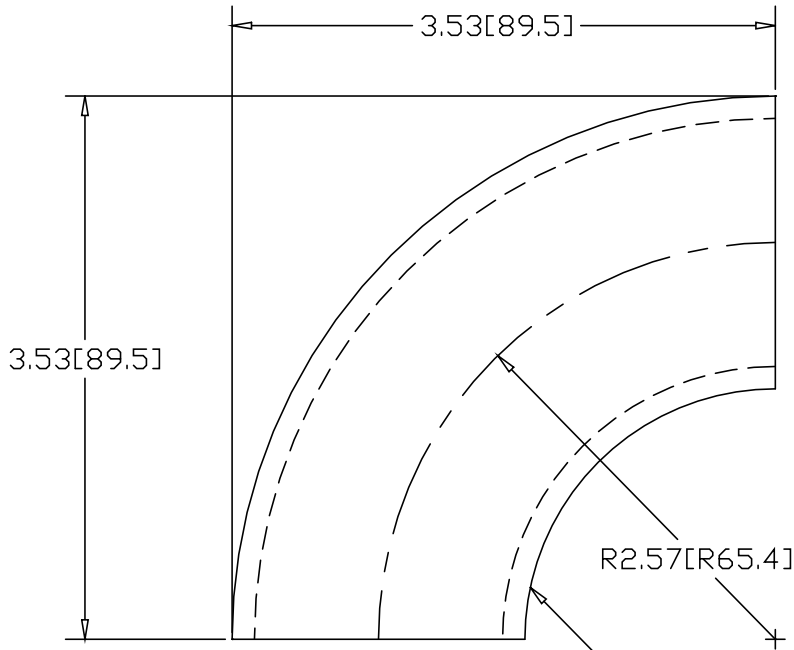

NOTE: UNWELDED SEAM
ALONG INSIDE RADIUS
(STEEL ELLS ONLY)

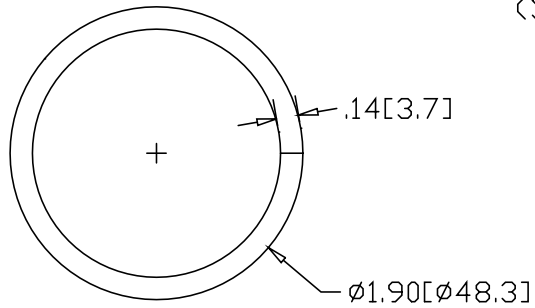

INCHES [MILLIMETERS]

ALTERNATE MATERIAL	PART NUMBER
1-1/2" SCH 40 (6063) ALUMINUM PIPE	4474
1-1/2" SCH 40 (304) STAINLESS STEEL PIPE	4684

PART NAME		1-1/2" PIPE SIZE 90° ELL X 1-5/8" I.R.					
MATERIAL		10 GA. HRP&D STEEL ASTM A569					
DATE	8/18/95	 R & B WAGNER, INC.					
DRAWN BY	RJF						
FINISH	MILL						
SIZE	A	WEIGHT	.81 LBS	PART NUMBER	4464	REV	