

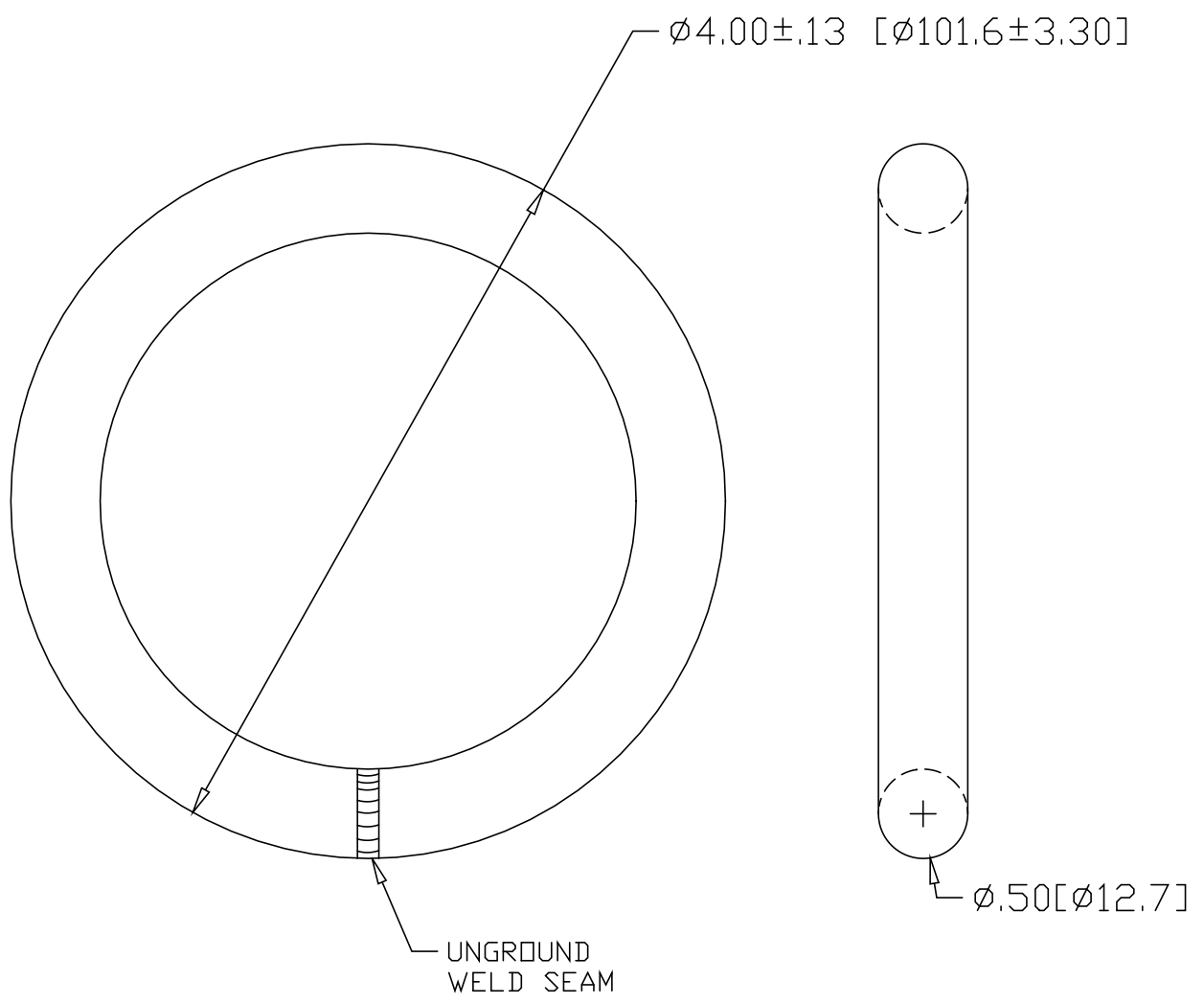

REV
SH
4365
DWG NO

REVISIONS			
REV	DESCRIPTION	DATE	APPROVED



INCHES [MILLIMETERS]

ALTERNATE MATERIAL	PART NUMBER
.50" DIA. (6063-T52) ALUMINUM BAR	4366
.50" DIA. (304) STAINLESS STEEL BAR	4367

PART NAME		.50" X 4.00" OUTSIDE DIAMETER RING					
MATERIAL		.50" DIA. (1018) CR STEEL BAR ASTM A108					
DATE	11/27/95	 THE WAGNER COMPANIES R & B WAGNER, INC. AND J. G. BRAUN CO.					
DRAWN BY	RJF						
FINISH	MILL						
SIZE	A	WEIGHT	.62 LBS	PART NUMBER	4365	REV	