

REV
SH
DWG NO 4180

REVISIONS			
REV	DESCRIPTION	DATE	APPROVED

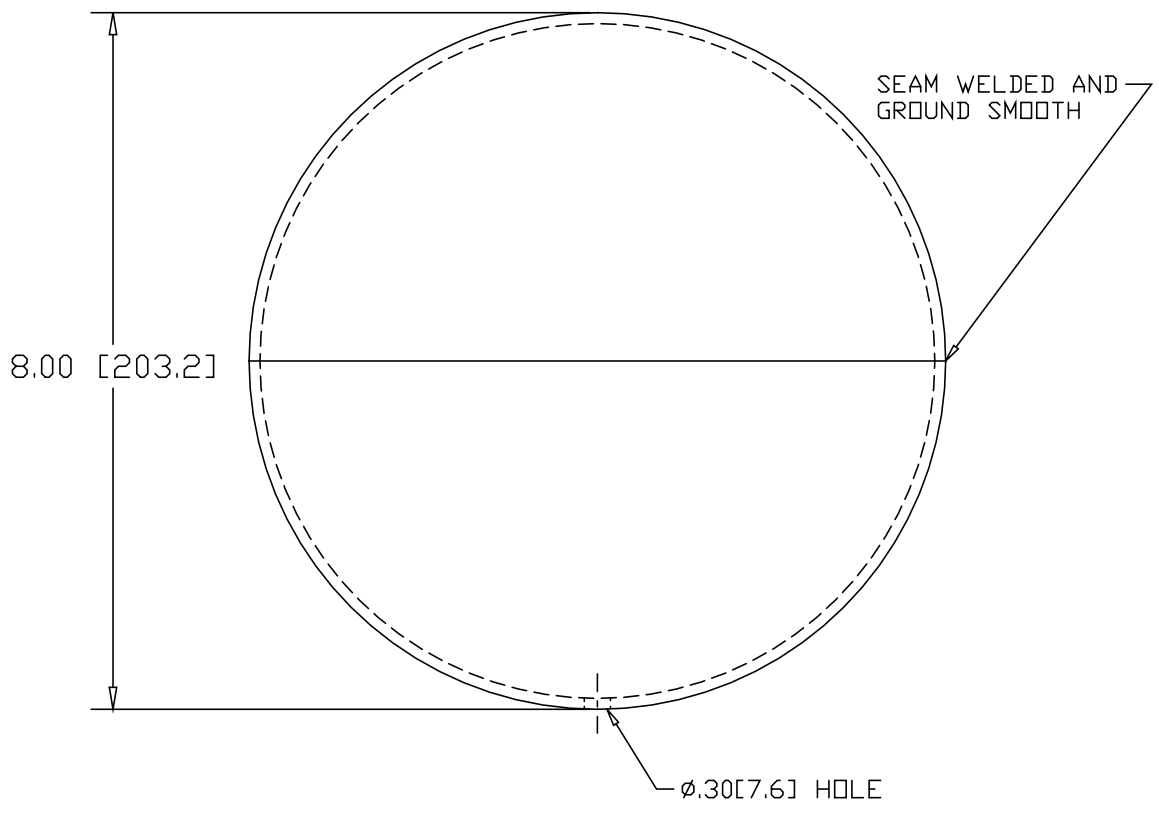

INCHES [MILLIMETERS]

ALTERNATE MATERIAL	PART NUMBER
.125 (3003) ALUMINUM SHEET ASTM B209	4182
11 GA. (.1200) 304 STAINLESS STEEL A240	4184
.125 (260) BRASS	4186
.125 (655) SILICON BRONZE	SB4180

PART NAME		8.00" DIAMETER HOLLOW BALL				
MATERIAL		11 GA. (.1196) HRP&D STEEL SHEET ASTM A569				
DATE	1/4/00		THE WAGNER COMPANIES R & B WAGNER, INC. AND J. G. BRAUN CO.			
DRAWN BY	RJF					
FINISH	MILL					
SIZE	A	WEIGHT	6.20 LBS	PART NUMBER	4180	REV