

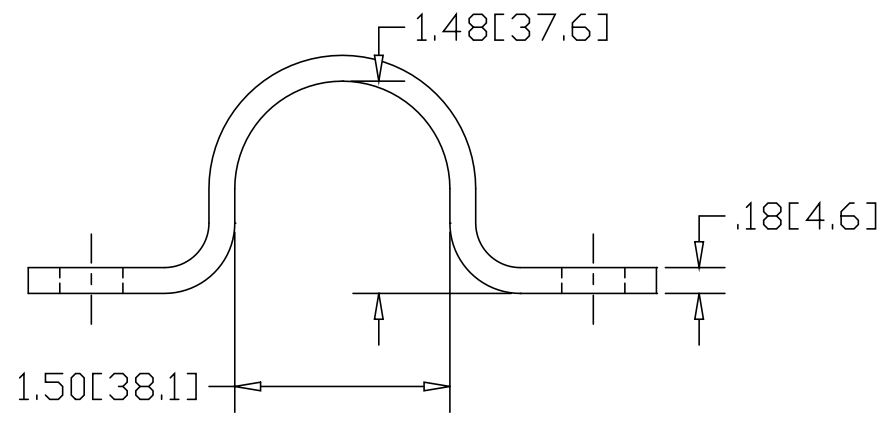

REV
SH
3726
DWG NO

REVISIONS			
REV	DESCRIPTION	DATE	APPROVED

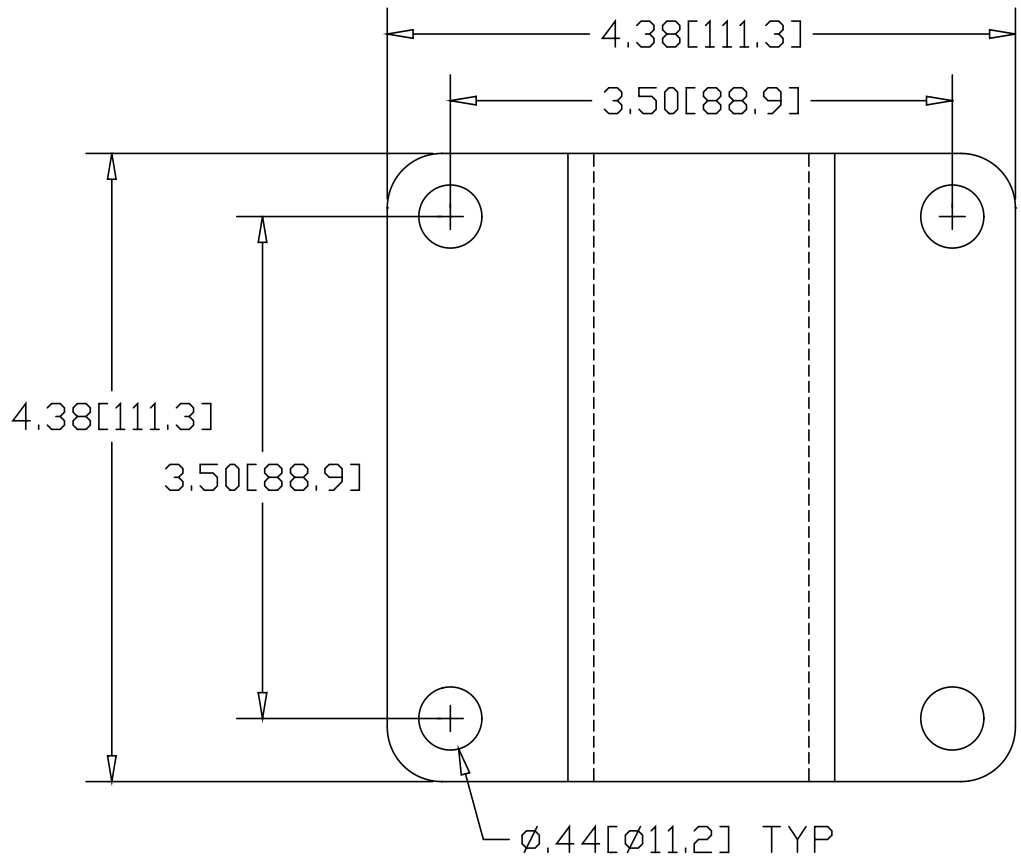

INCHES [MILLIMETERS]

ALTERNATE MATERIAL	PART NUMBER
.190 (3003) ALUMINUM ASTM B209	3726A
7 GA. (304) STAINLESS STEEL ASTM A240	3726-SS

PART NAME 1.50" OD TUBE X 4.38" WIDE U-BRACKET W/(4) HOLES				
MATERIAL 7 GA. HRP&D STEEL ASTM A569				
DATE 02/11/00	 THE WAGNER COMPANIES R & B WAGNER, INC. AND J. G. BRAUN CO.			
DRAWN BY RJF		SIZE A	WEIGHT 1.30 LBS	PART NUMBER 3726
FINISH MILL				REV