

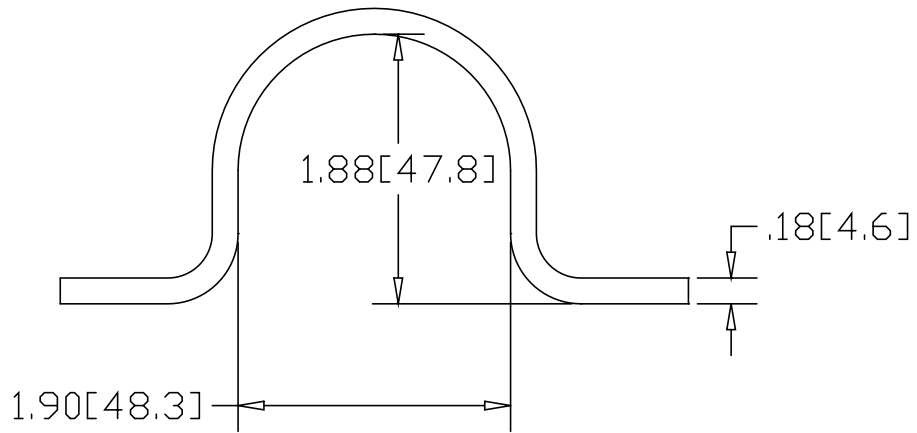

REV
SH
3684-NH
DWG NO

REVISIONS			
REV	DESCRIPTION	DATE	APPROVED

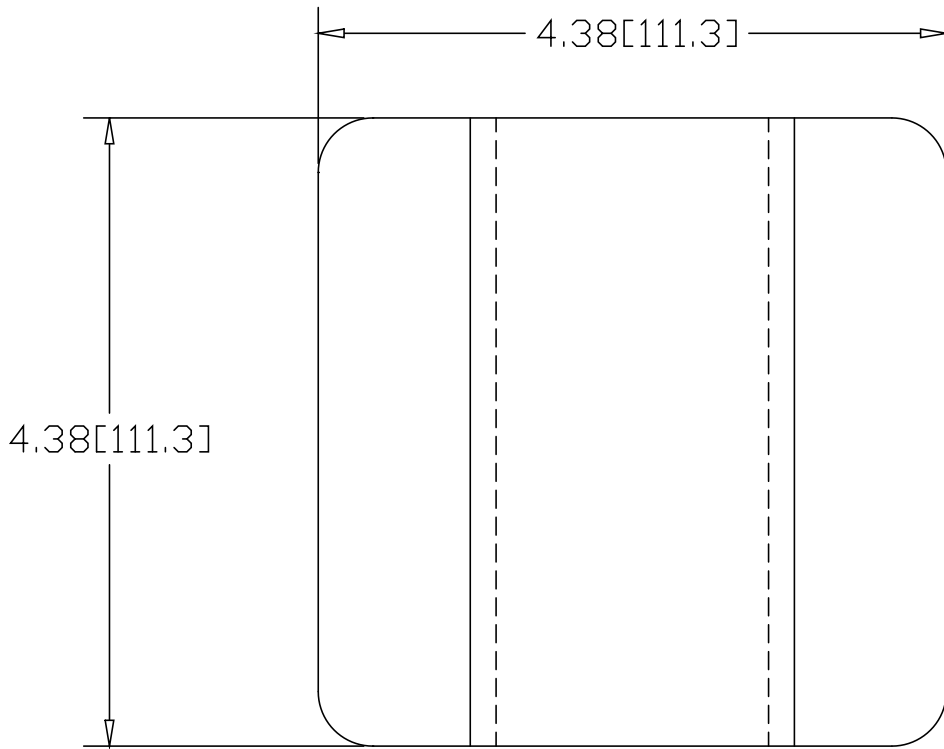

INCHES [MILLIMETERS]

ALTERNATE MATERIAL	PART NUMBER
.190 (3003) ALUMINUM ASTM B209	3685-NH
7 GA. (304) STAINLESS STEEL ASTM A240	3684-SS-NH

PART NAME		1-1/2" PIPE X 4.38" WIDE U-BRACKET					
MATERIAL		7 GA. HRP&D STEEL ASTM A569					
DATE	02/11/00	 THE WAGNER COMPANIES R & B WAGNER, INC. AND J. G. BRAUN CO.					
DRAWN BY	RJF						
FINISH	MILL						
SIZE	A	WEIGHT	1.41 LBS	PART NUMBER	3684-NH	REV	