

REV
SH
326
DWG NO

REVISIONS			
REV	DESCRIPTION	DATE	APPROVED

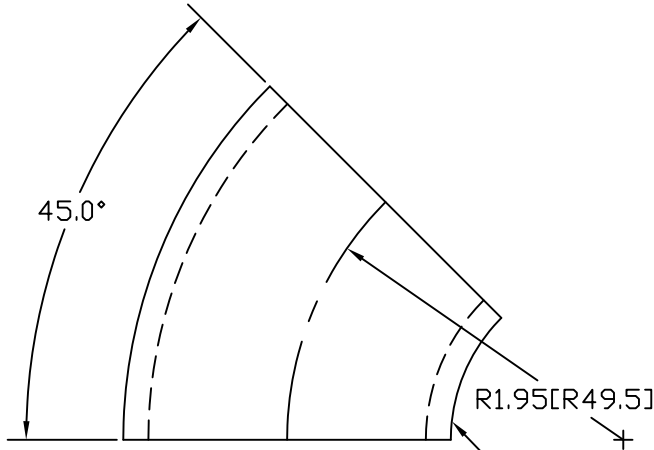

NOTE: UNWELDED SEAM ALONG INSIDE RADIUS

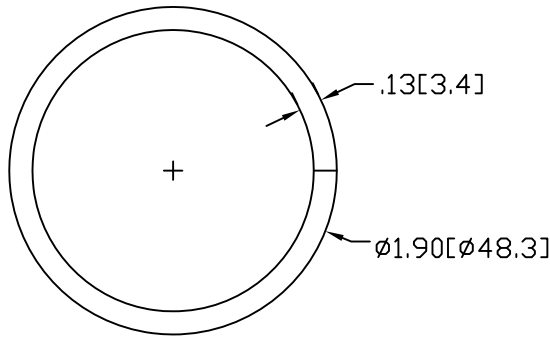

INCHES [MILLIMETERS]

ALTERNATE MATERIAL	PART NUMBER
.125 (3003) ALUMINUM ASTM B209	350
10 GA. (304) STAINLESS STEEL ASTM A240	375

PART NAME		1-1/2" PIPE 1" I.R. X 45° ELL		
MATERIAL		10 GA. HRP&D STEEL ASTM A569		
DATE	8/17/95	 R & B WAGNER, INC.		
DRAWN BY	RJF			
FINISH	MILL	SIZE	WEIGHT	PART NUMBER
		A	.34 LBS	326
				REV