

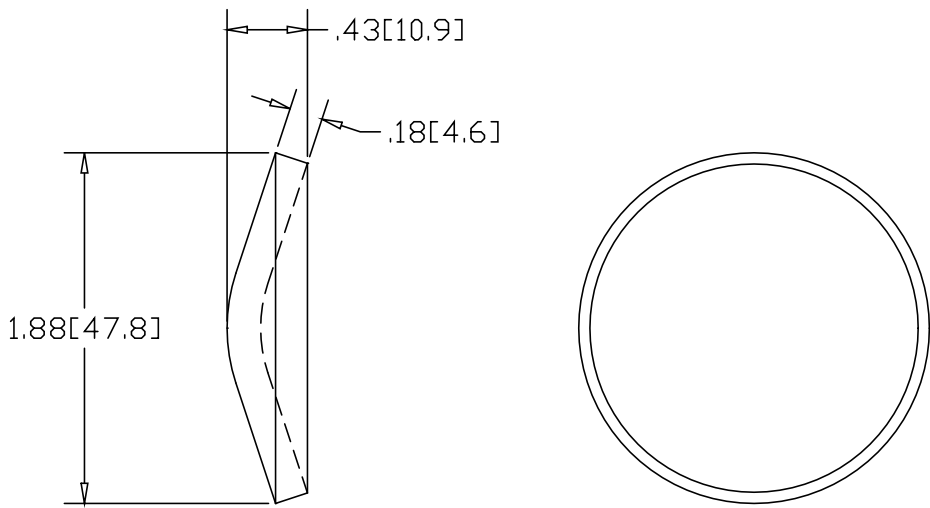

REV
SH
3229-F
DWG NO

REVISIONS			
REV	DESCRIPTION	DATE	APPROVED



INCHES [MILLIMETERS]

ALTERNATE MATERIAL		PART NUMBER	
.190 (3003) ALUMINUM ASTM B209		3249-F	
7 GA 304 STAINLESS STEEL ASTM A240		3269-F	
PART NAME 1-1/2" PIPE SIZE TYPE-F DISHED WELD-ON DISK			
MATERIAL 7 GA. HRP&D STEEL ASTM A569			
DATE	10/11/96	 THE WAGNER COMPANIES R & B WAGNER, INC. AND J. G. BRAUN CO.	
DRAWN BY	RJF		
FINISH	MILL		
SIZE	WEIGHT	PART NUMBER	REV
A	.14 LBS	3229-F	