

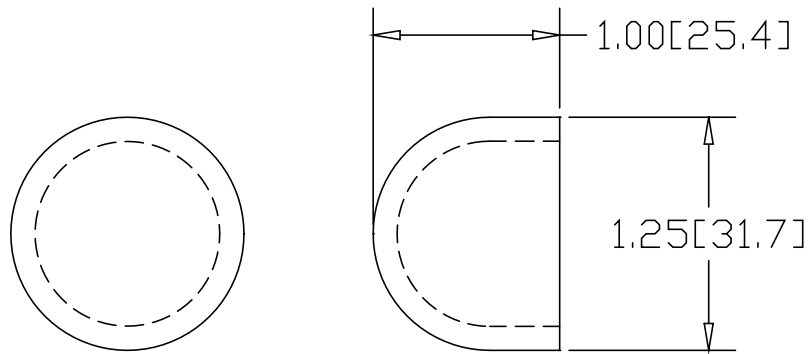

REV
SH
DWG NO 3233

REVISIONS			
REV	DESCRIPTION	DATE	APPROVED

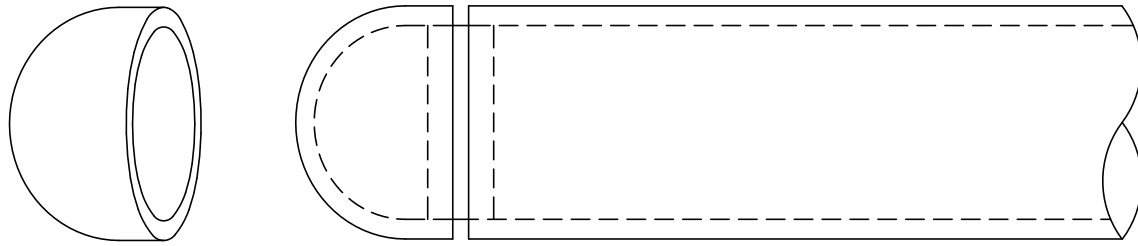

INCHES [MILLIMETERS]

ALTERNATE MATERIAL	PART NUMBER
.125 (3003) ALUMINUM ASTM B209	3234
10 GA. (304) STAINLESS STEEL ASTM A240	3263
.125 (260) BRASS ASTM B-19	BRS3233

PART NAME 1.25" OD TUBE SIZE TYPE "C" WELD-ON END CAP				
MATERIAL 10 GA. HRP&O STEEL ASTM A569				
DATE 3/31/95		THE WAGNER COMPANIES R & B WAGNER, INC. AND J. G. BRAUN CO.		
DRAWN BY RJF				
FINISH MILL	SIZE A	WEIGHT .1 LBS	PART NUMBER 3233	REV