

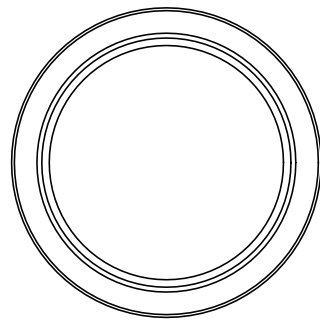

REV
SH
3231AM
DWG NO

REVISIONS			
REV	DESCRIPTION	DATE	APPROVED

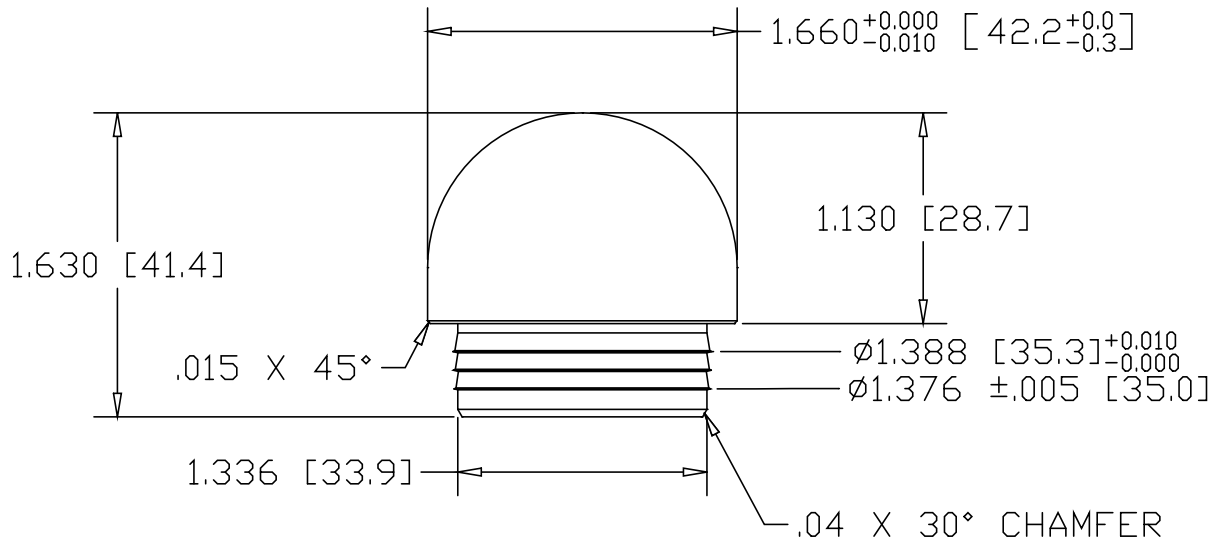

INCHES [MILLIMETERS]

PART NAME 1-1/4" PIPE SIZE TYPE-A MACHINED DRIVE-ON CAP			
MATERIAL 6063-T52 ALUMINUM			
DATE 04/20/05		THE WAGNER COMPANIES R & B WAGNER, INC. AND J. G. BRAUN CO.	
DRAWN BY RJF			
FINISH MILL			
SIZE A	WEIGHT .14 LBS	PART NUMBER 3231AM	REV