

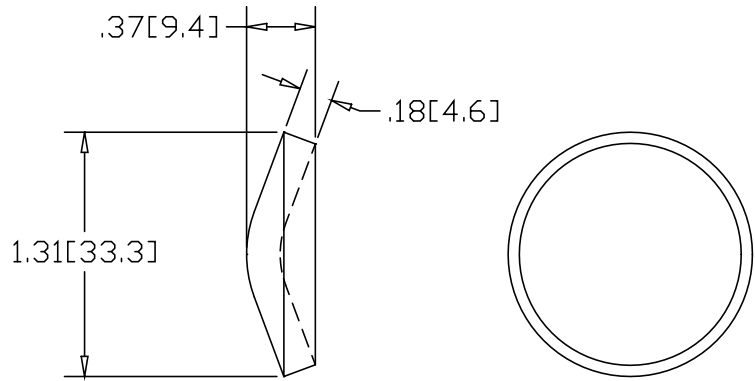

REV  
SH  
3227-F  
DWG NO

REVISIONS			
REV	DESCRIPTION	DATE	APPROVED



INCHES [MILLIMETERS]

ALTERNATE MATERIAL	PART NUMBER
.190 (3003) ALUMINUM ASTM B209	3247-F
7 GA 304 STAINLESS STEEL ASTM A240	3267-F

PART NAME				1" PIPE SIZE TYPE-F DISHED WELD-ON DISK			
MATERIAL				7 GA. HRP&O STEEL ASTM A569			
DATE		10/11/96		 <b>THE WAGNER COMPANIES</b> R & B WAGNER, INC. AND J. G. BRAUN CO.			
DRAWN BY		RJF					
FINISH		MILL					
SIZE	WEIGHT	PART NUMBER	REV				
A	.06 LBS	3227-F					