

REV
SH
262
DWG NO

REVISIONS			
REV	DESCRIPTION	DATE	APPROVED

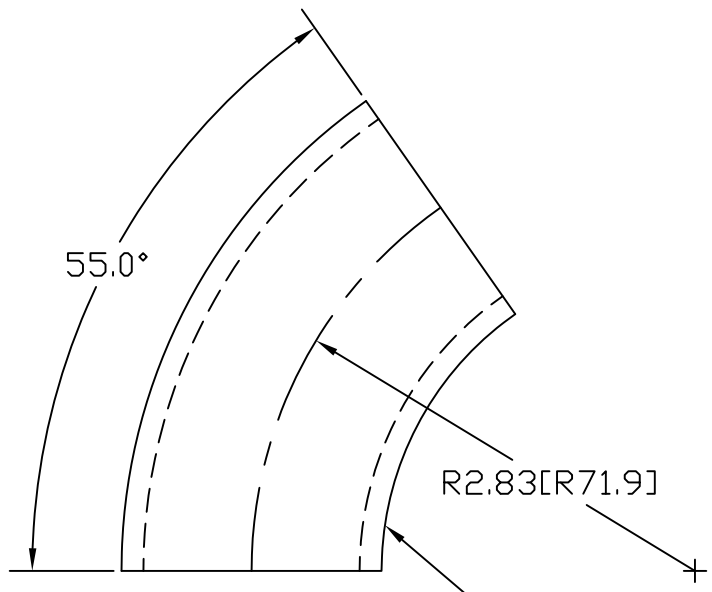

NOTE: UNWELDED SEAM
ALONG INSIDE RADIUS
(STEEL ELLS ONLY)

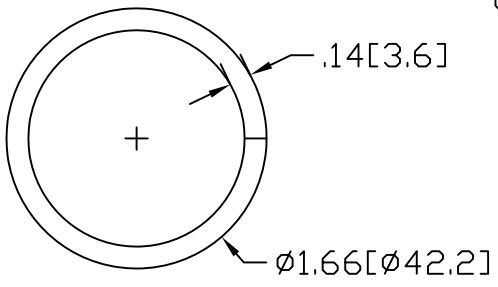

INCHES [MILLIMETERS]

ALTERNATE MATERIAL	PART NUMBER
1-1/4" SCH 40 (6063) ALUMINUM PIPE	286
1-1/4" SCH 40 (304) STAINLESS STEEL PIPE	311

PART NAME 1-1/4" PIPE SIZE 55° ELL X 2" I.R.				
MATERIAL 10 GA. HRP&D STEEL ASTM A569				
DATE 8/24/95	 R & B WAGNER, INC.			
DRAWN BY RJF				
FINISH MILL	SIZE A	WEIGHT .54 LBS	PART NUMBER 262	REV