

REV
SH
2075
DWG NO

REVISIONS			
REV	DESCRIPTION	DATE	APPROVED

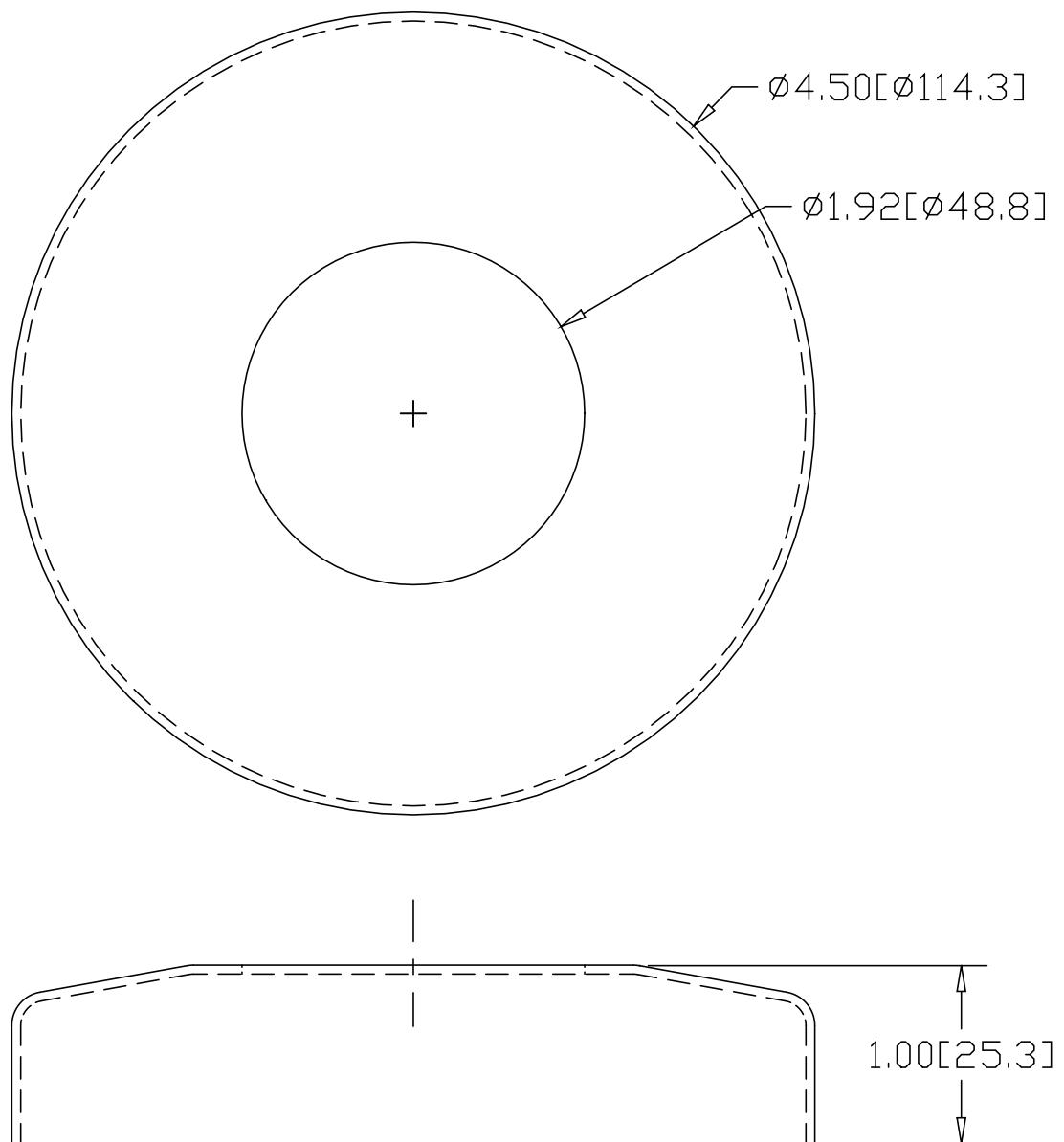

INCHES [MILLIMETERS]

* USE WITH BASE
 #2075B IN STEEL
 #2076B IN ALUMINUM
 #2077B IN STAINLESS
 #2078B IN BRASS

ALTERNATE MATERIAL	PART NUMBER
.063 (3003) ALUMINUM ASTM B209	2076
18 GA. (304) STAINLESS STEEL A240	2077
.050 (280) MUNTZ METAL	2078

PART NAME		1-1/2" PIPE SNAP COVER	
MATERIAL		18 GA. CR STEEL ASTM A366	
DATE	4/3/97	 R & B WAGNER, INC.	
DRAWN BY	RJF		
FINISH	MILL	SIZE	A
		WEIGHT	.29 LBS
		PART NUMBER	2075
		REV	