

REV  
SH  
2041B  
DWG NO

REVISIONS			
REV	DESCRIPTION	DATE	APPROVED

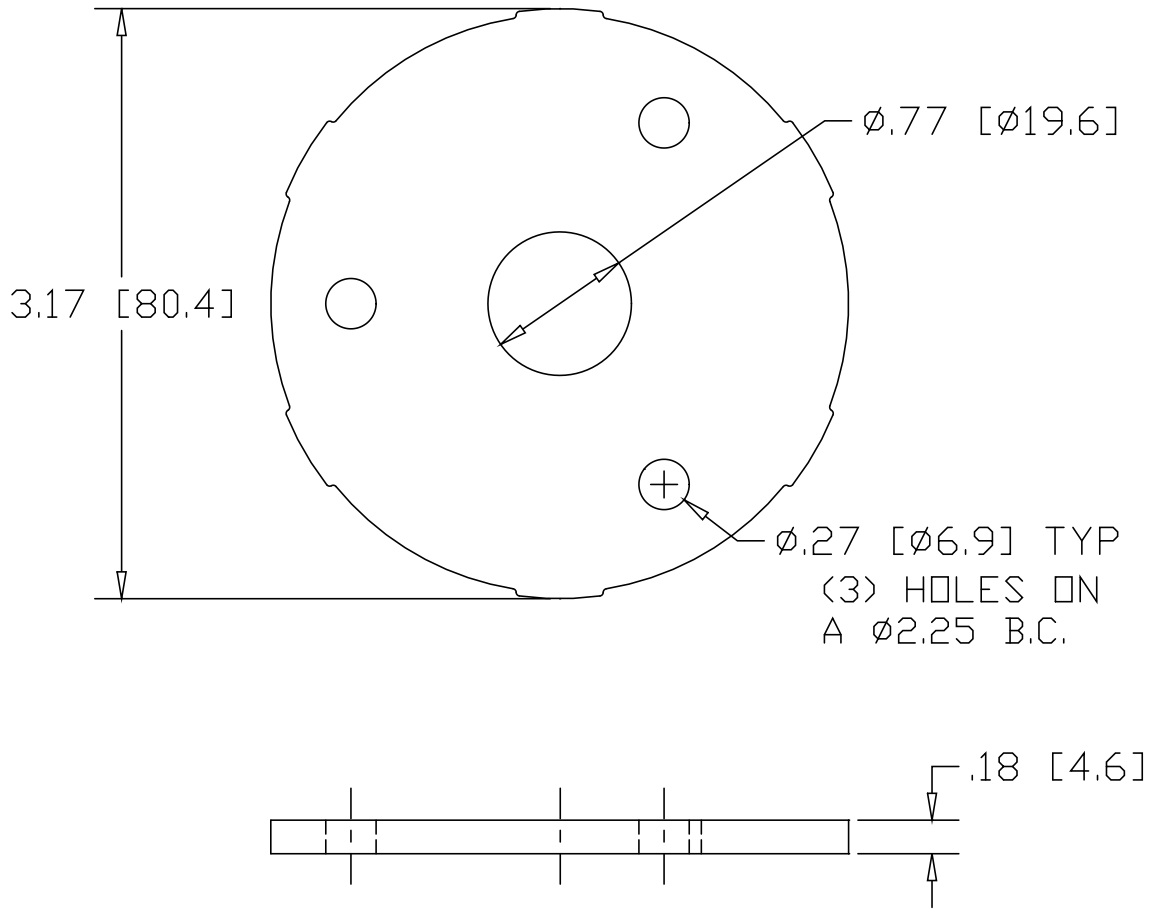

\* USE WITH SNAP-COVER  
 #2041 IN STEEL  
 #2042 IN ALUMINUM  
 #2043 IN STAINLESS  
 #2044 IN BRASS

INCHES [MILLIMETERS]

ALTERNATE MATERIAL	PART NUMBER
.190 (3003) ALUMINUM ASTM B209	2042B
7 GA. (304) STAINLESS STEEL A240	2043B
.18 (260) BRASS B19,B36	2044B

PART NAME		.750" OD TUBE SNAP COVER BASE	
MATERIAL		7 GA. HRP&O STEEL ASTM A569	
DATE	8/15/96	 <b>R &amp; B WAGNER, INC.</b>	
DRAWN BY	RJF		
FINISH	MILL	SIZE	A
		WEIGHT	.39 LBS
		PART NUMBER	2041B
			REV