

REV
SH
1661-T
DWG NO

REVISIONS			
REV	DESCRIPTION	DATE	APPROVED

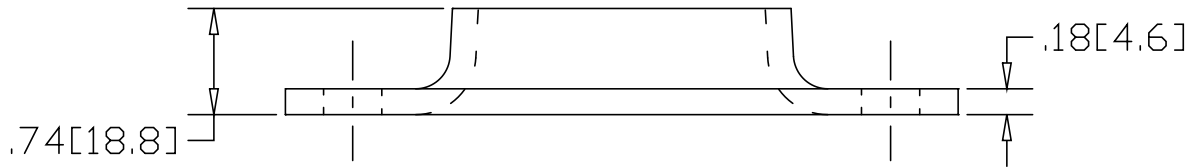
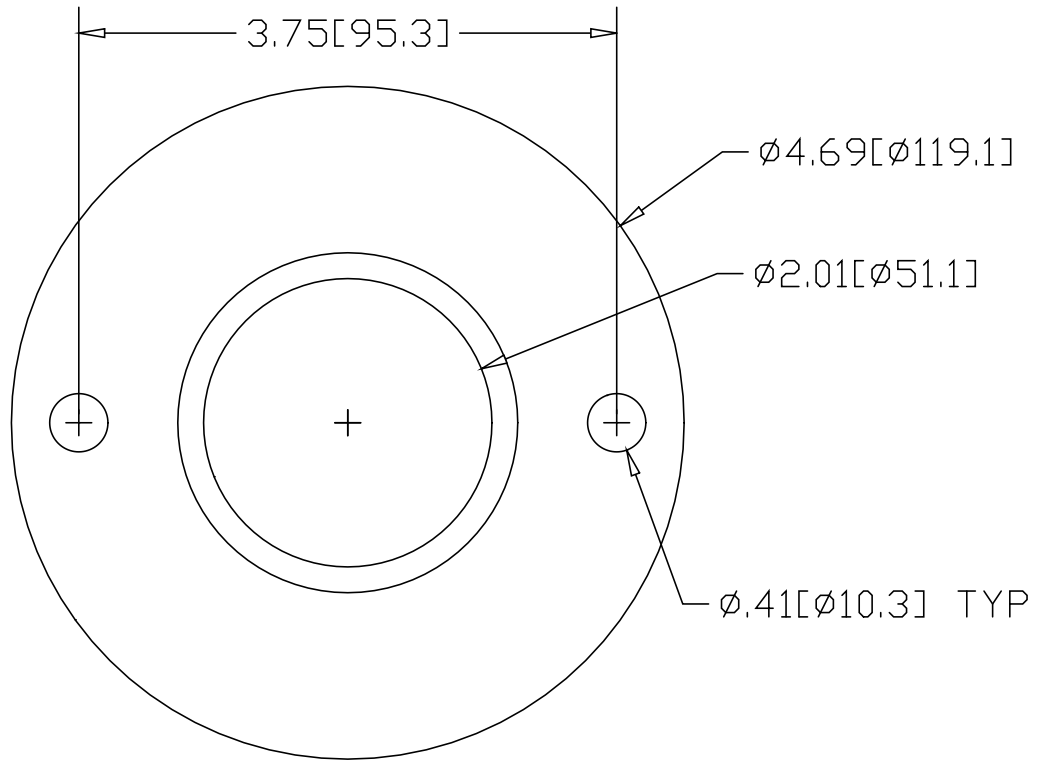

INCHES [MILLIMETERS]

* USE WITH ANCHOR PLATE
#B1628 IN STEEL
#B1648 IN ALUMINUM

ALTERNATE MATERIAL	PART NUMBER
.190" (3003) ALUMINUM ASTM B-209	1671-T
7 GA. (304) STAINLESS STEEL ASTM A240	1661-TSS

PART NAME 2" O.D. TUBE EXTRA HEAVY FLANGE W/(2) HOLES			
MATERIAL 7 GA. HPR&D STEEL ASTM A-569			
DATE 3/2/95	 R & B WAGNER, INC.		
DRAWN BY RJF			
FINISH MILL	SIZE A	WEIGHT .81 LBS	PART NUMBER 1661-T
			REV