

REV
SH
1611-T
DWG NO

REVISIONS			
REV	DESCRIPTION	DATE	APPROVED

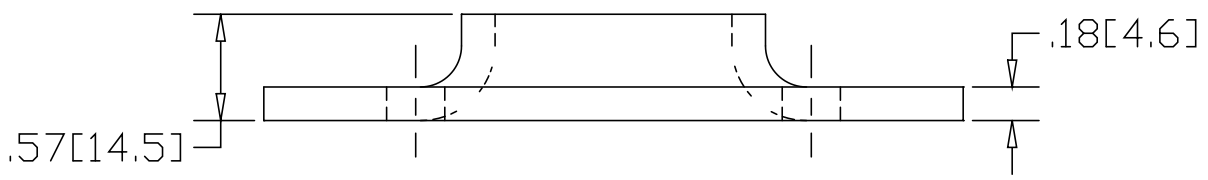
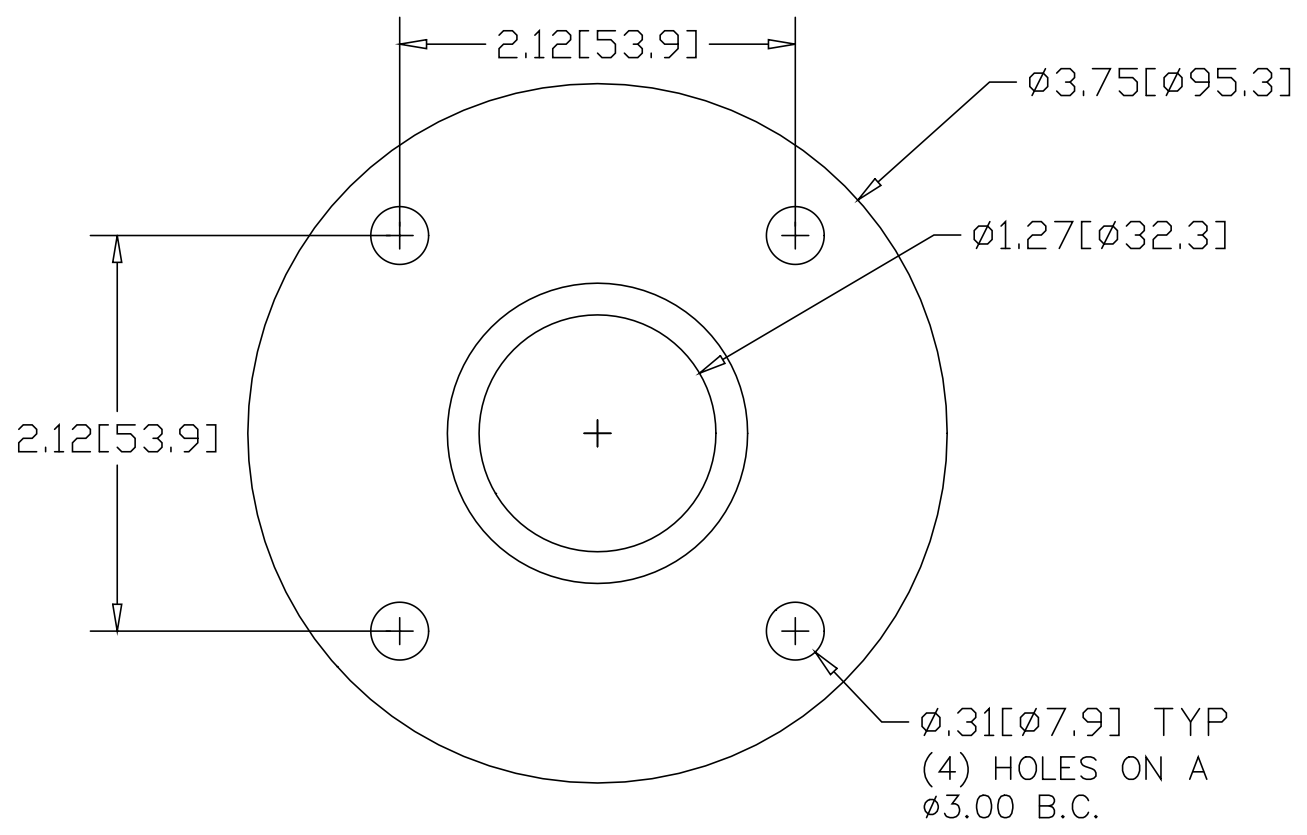

*USE WITH ANCHOR PLATE
#B1616 IN STEEL
#B1638 IN ALUMINUM

INCHES [MILLIMETERS]

ALTERNATE MATERIAL	PART NUMBER
.190 (3003) ALUMINUM ASTM B209	1633-T

PART NAME 1.25" OD TUBE EXTRA HEAVY FLANGE WITH (4) HOLES			
MATERIAL 3/16" HRP&O STEEL ASTM A-569			
DATE 3/17/99			
DRAWN BY RJF			
FINISH MILL	SIZE A	WEIGHT .56 LBS	PART NUMBER 1611-T
			REV