

REV
SH
1444
DWG NO

REVISIONS			
REV	DESCRIPTION	DATE	APPROVED

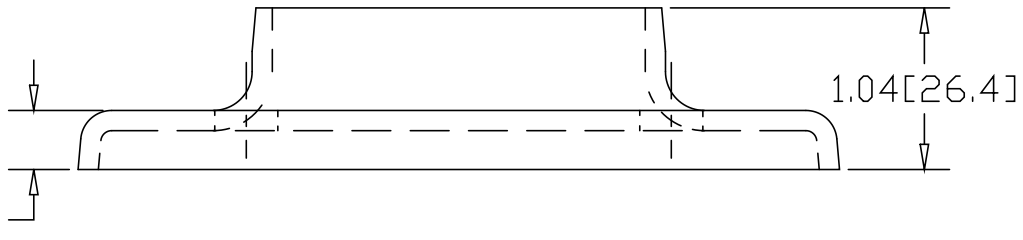
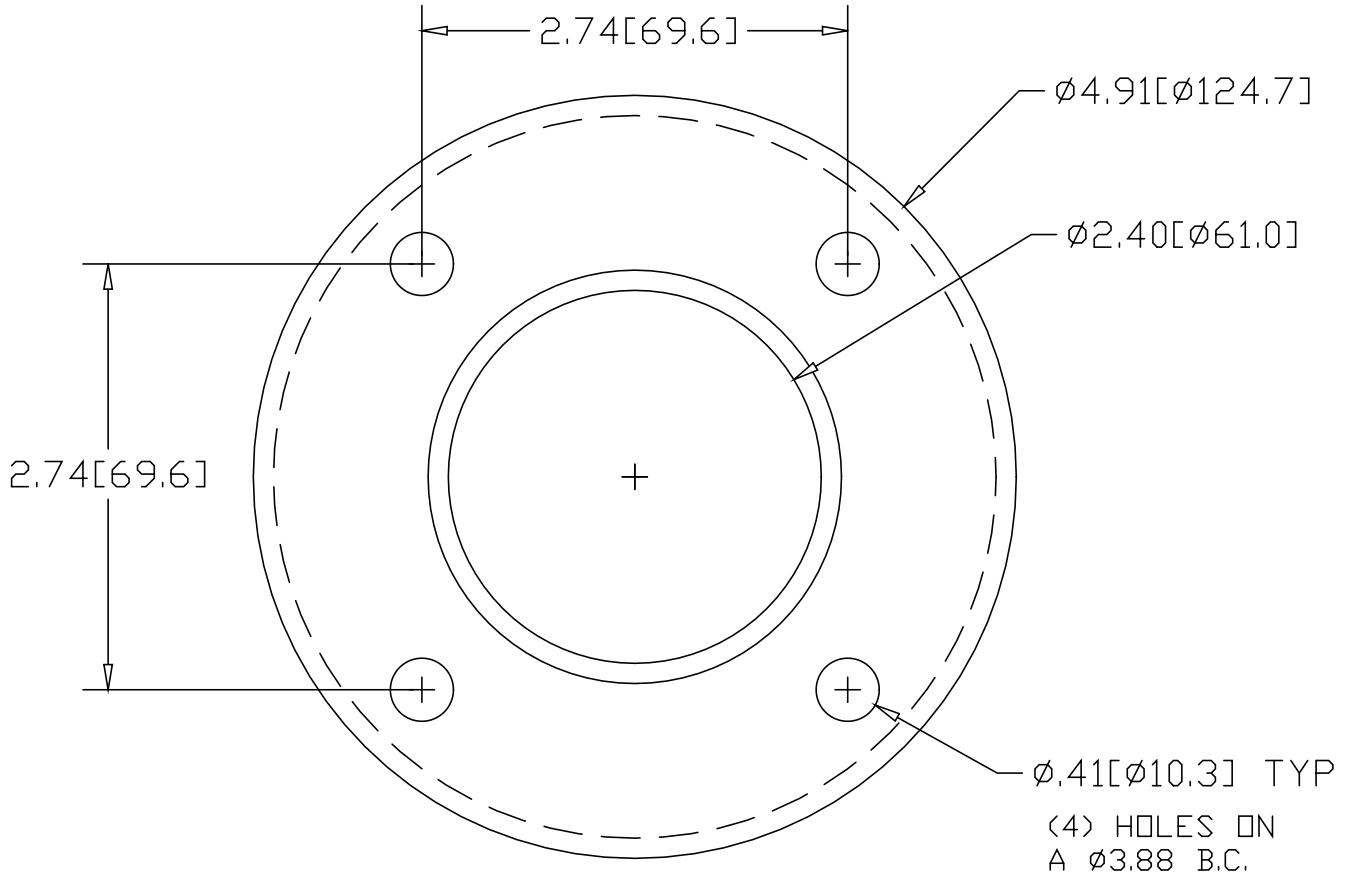

INCHES [MILLIMETERS]

*USE WITH ANCHOR PLATE
 #B1448 IN STEEL
 #PLB1448 ZINC PLATED STEEL
 #B1548 IN STAINLESS

ALTERNATE MATERIAL	PART NUMBER
.125 (3003) ALUMINUM ASTM B209	1484
10 GA. (304) STAINLESS STEEL ASTM A240	1544

PART NAME 2" PIPE HEAVY BASE FLANGE W/(4) HOLES			
MATERIAL 10 GA. HRP&D STEEL ASTM A569			
DATE 9/14/94			
DRAWN BY RJF			
FINISH MILL			
SIZE A	WEIGHT .72 LBS	PART NUMBER 1444	REV