

REV
SH
1431
DWG NO

REVISIONS			
REV	DESCRIPTION	DATE	APPROVED

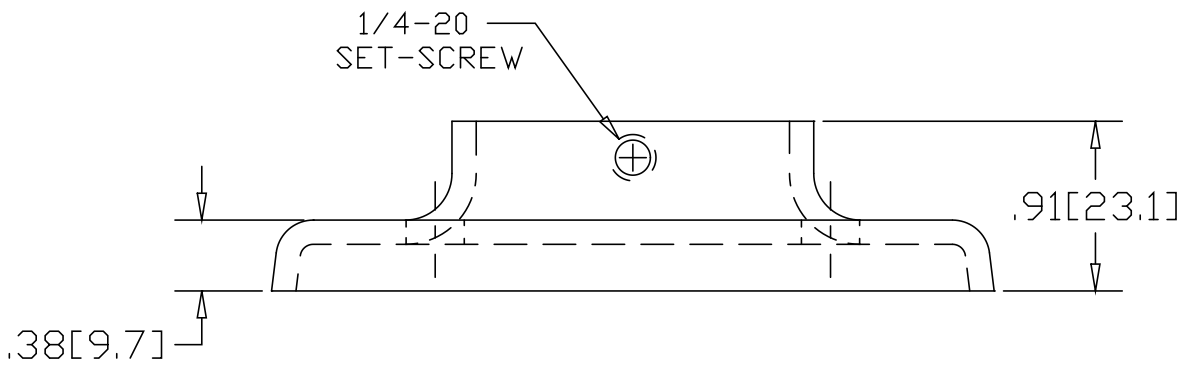
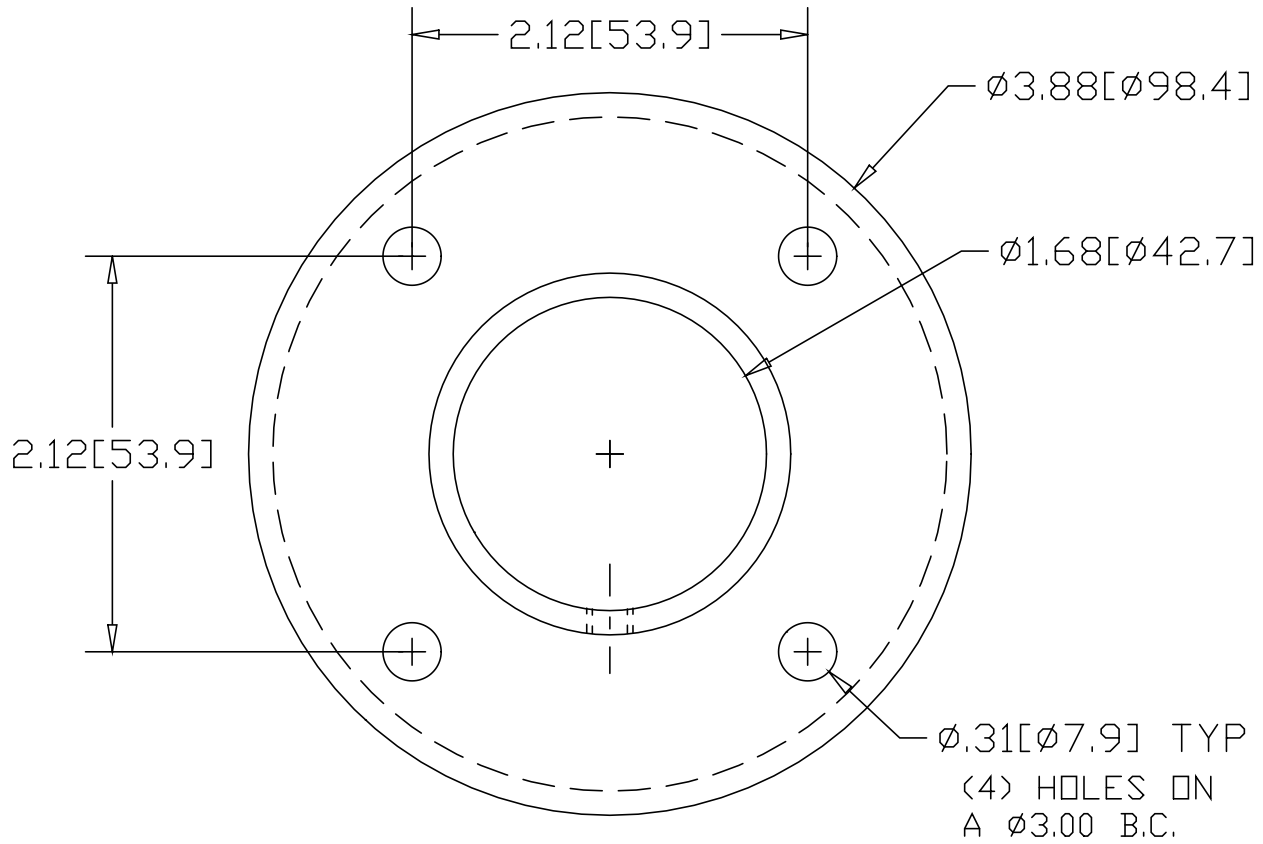

INCHES [MILLIMETERS]

ALTERNATE MATERIAL	PART NUMBER
.125 (3003) ALUMINUM ASTM B209	1471
10 GA. (304) STAINLESS STEEL ASTM A240	1531

PART NAME 1-1/4" PIPE HEAVY BASE FLANGE W/(4) HOLES & SET-SCREW				
MATERIAL 10 GA. HRP&D STEEL ASTM A569				
DATE 9/13/94				
DRAWN BY RJF				
FINISH MILL	SIZE A	WEIGHT .50 LBS	PART NUMBER 1431	REV