

REV
SH
1428T
DWG NO

REVISIONS			
REV	DESCRIPTION	DATE	APPROVED

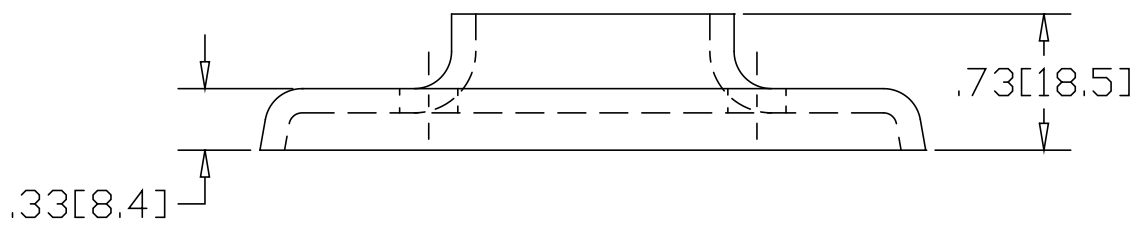
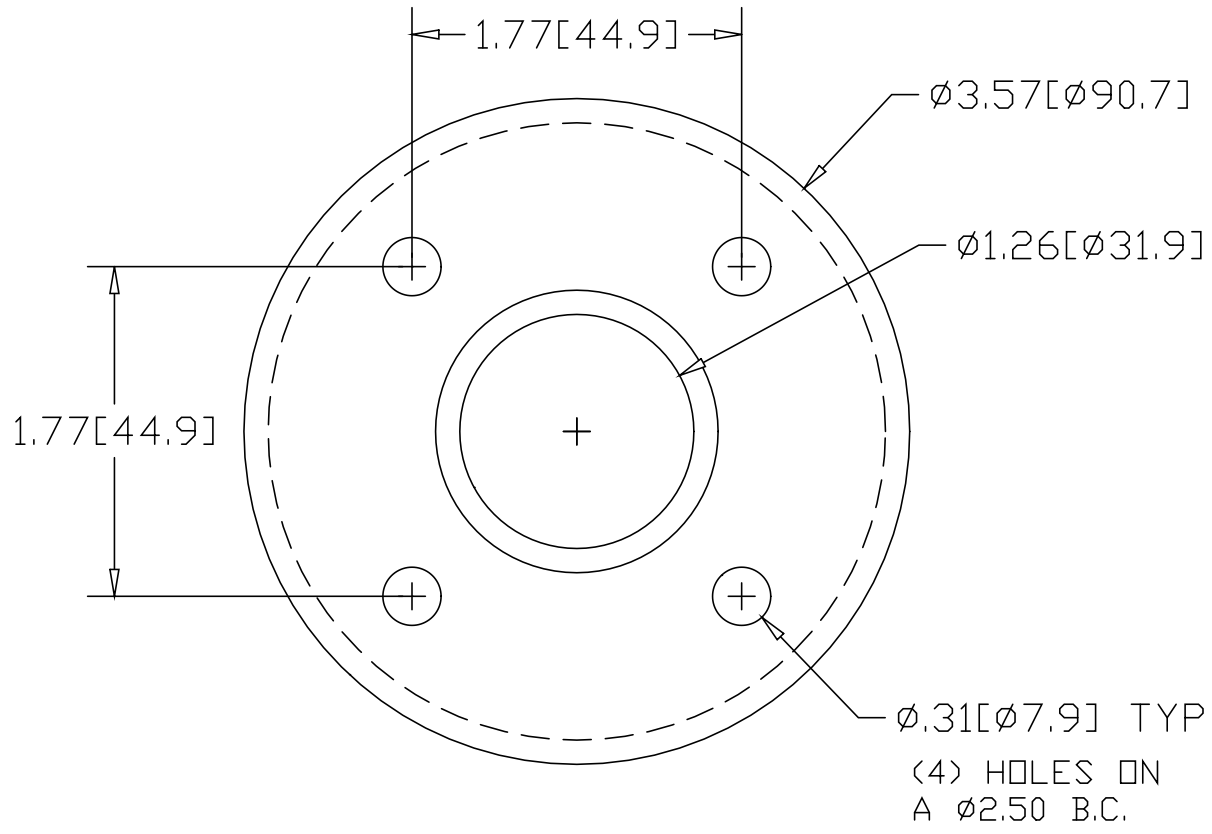

INCHES [MILLIMETERS]

*USE WITH ANCHOR PLATE
#B1416 IN STEEL
#PLB1416 ZINC PLATED STEEL
#B1516 IN STAINLESS

ALTERNATE MATERIAL	PART NUMBER
.125 (3003) ALUMINUM ASTM B209	1468T
10 GA. (304) STAINLESS STEEL ASTM A240	1528T

PART NAME 1.25" OD TUBE HEAVY BASE FLANGE W/(4) HOLES			
MATERIAL 10 GA. HRP&D STEEL ASTM A569			
DATE 9/13/94		R & B WAGNER, INC.	
DRAWN BY RJF			
FINISH MILL			
SIZE A	WEIGHT .41 LBS	PART NUMBER 1428T	REV