

REV
SH
1145-1
DWG NO

REVISIONS			
REV	DESCRIPTION	DATE	APPROVED

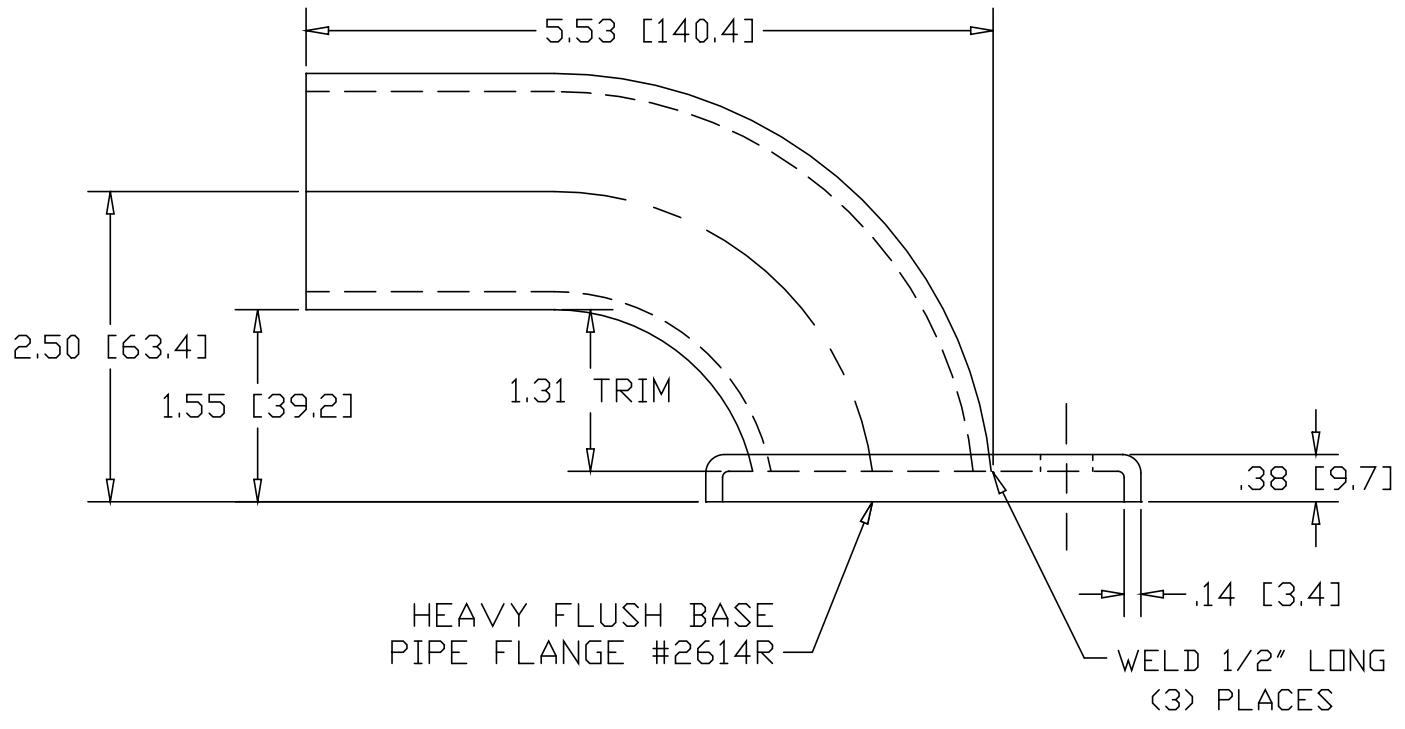
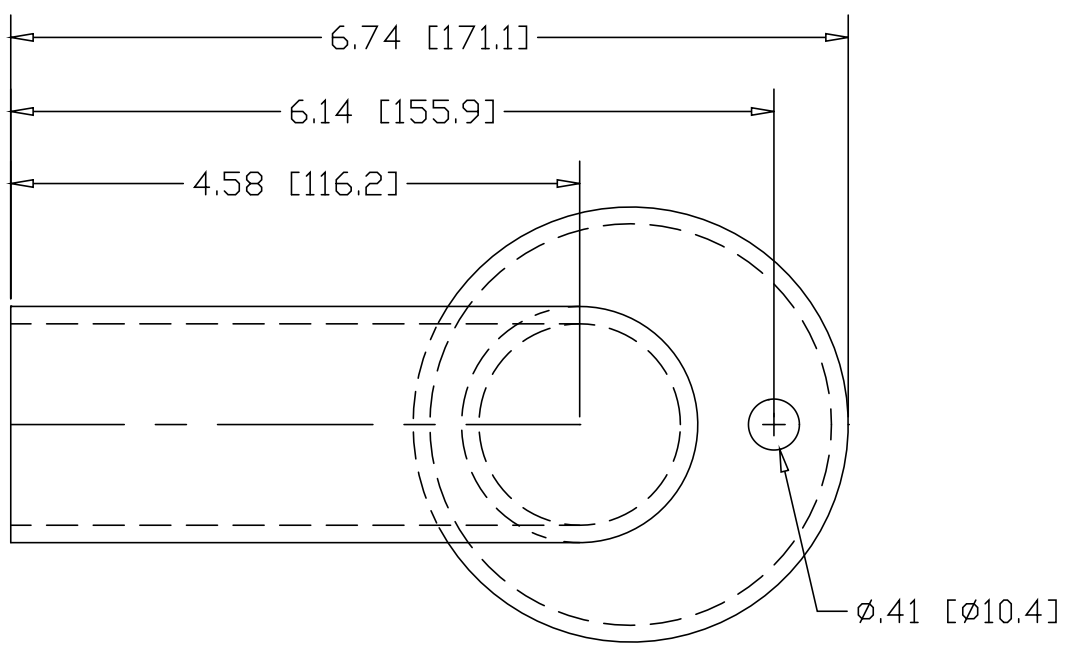

INCHES [MILLIMETERS]

PART NAME 1-1/2" PIPE SIZE X 2.50CL WALL RETURN W/1 HOLE			
MATERIAL STAINLESS STEEL ASTM-A312			
DATE 12/27/02		THE WAGNER COMPANIES R & B WAGNER, INC. AND J. G. BRAUN CO.	
DRAWN BY JAH			
FINISH #4 SATIN			
SIZE A	WEIGHT	PART NUMBER 1145-1	REV